



RX-V10MKII

AV RECEIVER

AMPLI-TUNER AUDIO-VIDEO

**OWNER'S MANUAL
MODE D'EMPLOI
BEDIENUNGSANLEITUNG
BRUKSANVISNING
MANUALE DI ISTRUZIONI
MANUAL DE INSTRUCCIONES
GEBRUIKSAANWIJZING**

CAUTION : READ THIS BEFORE OPERATING YOUR UNIT.

1. To assure the finest performance, please read this manual carefully. Keep it in a safe place for future reference.
2. Install this unit in a cool, dry, clean place – away from windows, heat sources, sources of excessive vibration, dust, moisture and cold. Avoid sources of humming (transformers, motors). To prevent fire or electrical shock, do not expose the unit to rain or water.
3. Never remove the unit cover. Contact your dealer if an object falls inside the unit.
4. Do not use force on switches, controls or connection wires. When moving the unit, first disconnect the power plug and the wires connected to other equipment. Never pull on the wires themselves.
5. The openings on the unit cover assure proper ventilation of the unit. If these openings are obstructed, the temperature inside the unit will rise rapidly. Therefore, avoid placing objects against these openings, and install the unit in a well-ventilated area to prevent fire and damage.
<Europe and U.K. models only>
Be sure to allow a space of at least 20 cm behind, 20 cm on the both sides and 30 cm above the top panel of the unit to prevent fire and damage.
6. The voltage used must be the same as that specified on this unit. Using this unit with a higher voltage than specified is dangerous and may result in fire or other accidents. YAMAHA will not be held responsible for any damage resulting from use of this unit with a voltage other than specified.
7. Always set the VOLUME control to “0” before starting the audio source play. Increase the volume gradually to an appropriate level after playback has been started.
8. Do not attempt to clean the unit with chemical solvents; this might damage the finish. Use a clean, dry cloth.
9. Be sure to read the “TROUBLESHOOTING” section regarding common operating errors before concluding that the unit is faulty.
10. When not planning to use this unit for long periods of time, disconnect the AC power plug from the wall outlet.
11. To prevent lightning damage, disconnect the AC power plug and antenna cable when there is an electrical storm.
12. Grounding or polarization – Precautions should be taken so that the grounding or polarization of an appliance is not defeated.
13. Do not connect audio unit to the AC outlet on the rear panel if the equipment requires more power than the outlet is rated to provide.
14. **Voltage Selector (General Model only)**
The voltage selector on the rear panel of this unit must be set for your local main voltage BEFORE plugging into the AC main supply.
Voltages are 110/120/220/240 V AC, 50/60 Hz.

IMPORTANT

Please record the serial number of your unit in the space below.

Model:

Serial No.:

The serial number is located on the rear of the unit. Retain this Owner's Manual in a safe place for future reference.

WARNING

TO REDUCE THE RISK OF FIRE OR ELECTRIC SHOCK, DO NOT EXPOSE THIS UNIT TO RAIN OR MOISTURE.

FREQUENCY STEP switch (General Model only)

Because the interstation frequency spacing differs in different areas, set the FREQUENCY STEP switch (located at the rear) according to the frequency spacing in your area. Before setting this switch, disconnect the AC power plug of this unit from the AC outlet.

For U.K. customers

If the socket outlets in the home are not suitable for the plug supplied with this appliance, it should be cut off and an appropriate 3 pin plug fitted. For details, refer to the instructions described below.

Note: The plug severed from the mains lead must be destroyed, as a plug with bared flexible cord is hazardous if engaged in a live socket outlet.

Special Instructions for U.K. Model

IMPORTANT

THE WIRES IN MAINS LEAD ARE COLOURED IN ACCORDANCE WITH THE FOLLOWING CODE:

Blue: NEUTRAL

Brown: LIVE

As the colours of the wires in the mains lead of this apparatus may not correspond with the coloured markings identifying the terminals in your plug, proceed as follows: The wire which is coloured BLUE must be connected to the terminal which is marked with the letter N or coloured BLACK. The wire which is coloured BROWN must be connected to the terminal which is marked with the letter L or coloured RED. Making sure that neither core is connected to the earth terminal of the three pin plug.

This unit is not disconnected from the AC power source as long as it is connected to the wall outlet, even if this unit itself is turned off. This state is called the standby mode. In this mode, this unit is designed to consume a small amount of power.

Thank you for selecting this YAMAHA AV receiver.

CONTENTS

CAUTION	2	BASIC TUNING OPERATION	27
FEATURES	4	Automatic tuning	27
PROFILE OF THIS UNIT	5	Manual tuning	27
GETTING STARTED	6	PRESET TUNING	28
Unpacking	6	Manual preset tuning	28
Opening and closing the front cover	6	Automatic preset tuning	29
Installing batteries in the remote controller	7	Exchanging preset stations	30
Using the remote controller	7	RECEIVING RDS STATIONS <Europe and U. K. models only>	31
SPEAKER SET UP	8	Displaying RDS data	31
CONNECTIONS	9	Selecting your desired program type from among preset RDS stations (PTY SEEK)	34
Connecting audio and video components	9	Automatic selection of desired program when broadcasting starts	35
Connecting speakers	12	USING DIGITAL SOUND FIELD PROCESSOR (DSP)	36
Connecting antennas	14	Brief overview of Digital Sound Field Programs	36
CONTROLS AND THEIR FUNCTIONS	16	Playing a source with an effect of the digital sound field processor (DSP)	37
Front panel	16	TROUBLESHOOTING	40
Remote controller	18	SPECIFICATIONS	41
Display panel	20		
SPEAKER BALANCE ADJUSTMENT	21		
PLAYING AND RECORDING A SOURCE	24		
Playing a source	24		
Recording a source to tape (or MD)	25		
Sound control	26		

FEATURES

- **5 Speaker Configuration (Power Amp. Section)**
 - Main: 45W + 45W (8Ω) RMS Output Power, 0.04% THD, 20–20,000 Hz**
 - Center: 45W (8Ω) RMS Output Power, 0.04% THD, 1 kHz**
 - Rear: 15W + 15W (8Ω) RMS Output Power, 0.3% THD, 1 kHz**
 - **Digital Sound Field Processor**
 - **Dolby Pro Logic Surround Decoder**
 - **Theater-like Sound Experience by the Combination of Dolby Pro Logic and YAMAHA DSP Technology (CINEMA DSP)**
 - **Automatic Input Balance Control for Dolby Pro Logic Surround**
 - **Test Tone Generator for Easier Speaker Balance Adjustment**
 - **3 Center Channel Modes (NORMAL/WIDE/PHANTOM)**
 - **40-Station Random Access Preset Tuning**
 - **Automatic Preset Tuning**
 - **Preset Station Shifting Capability (Preset Editing)**
 - **IF Count Direct PLL Synthesizer Tuning System**
 - **On Screen Display Function Helpful in Controlling This Unit**
 - **6-Channel Discrete Input Terminals for Connecting with a Dolby Digital or Another 5.1-channel Decoder**
 - **Video Signal Input/Output Capability**
 - **SLEEP Timer**
 - **Remote Control Capability**
- <Europe and U.K. models only>
- **Multi-Functions for RDS Broadcast Reception**

PROFILE OF THIS UNIT

You are the proud owner of a Yamaha stereo receiver –an extremely sophisticated audio component. The Digital Sound Field Processor (DSP) built into this unit takes advantage of Yamaha's undisputed leadership in the field of digital audio processing to bring you a whole new world of listening experiences. Follow the instructions in this manual carefully when setting up your system, and this unit will sonically transform your room into a wide range of listening environments –movie theater, concert hall, and so on. In addition, you get incredible realism from sources encoded with Dolby Surround using the built-in Dolby Pro Logic Surround Decoder.

Please read this operation manual carefully and store it in a safe place for later reference.

Digital Sound Field Processing

Technological advances in sound reproduction over the last 30 years have enhanced the listening experience with improved clarity, precision and power. However, something has still been missing: The atmosphere and acoustic ambiance of the public venue. Our Yamaha engineers have extensively researched the nature of sound acoustics and the way sound reflects inside a room. We sent these engineers to famous theaters and concert halls around the world to measure the acoustics of those venues with sophisticated microphones. The data they collected is used to recreate these environments in digital

sound fields. Some of these digital sound fields are created using data measured directly at the original venue; others are created from combinations of data to form unique environments for specific purposes.

You can use these sound fields to enhance any source and in combination with the Dolby Pro Logic Surround technology. Some are designed especially for music, and some especially for movies.

Dolby Pro Logic Surround

Dolby Pro Logic Surround has been used in movie theaters since the mid-seventies. It has also been available in home entertainment systems since the late eighties and continues to be a popular format for home theater systems. It uses four discrete channels and five speakers to reproduce realistic and dynamic sound effects: two main channels (left and right), a center channel for dialog, and a rear channel for special sound effects. The rear channel reproduces sound within a narrow frequency range.

Most video tapes and laser discs include Dolby Pro Logic Surround encoding as do many TV and cable broadcasts. The Dolby Pro Logic Surround decoder built into this unit employs a digital signal processing system that stabilizes each channel for even more accurate sound positioning than is available with standard analog processors.

Manufactured under license from Dolby Laboratories Licensing Corporation. DOLBY, the double-D symbol and PRO LOGIC are trademarks of Dolby Laboratories Licensing Corporation.

Dolby Pro Logic Surround + DSP

The Dolby Surround sound system shows its full ability in a large movie theater, because movie sounds are originally designed to be reproduced in a large movie theater that uses a multitude of speakers. Trying to create a sound environment similar to that of a movie theater in your home is difficult because of the room size, material inside the walls, number of speakers, and so on. In other words, your listening room is very different from a movie theater.

However, Yamaha DSP technology allows you to create nearly the same sound experience as that of a large movie theater in your home by compensating for the lack of presence and dynamics in the listening room with its original digital sound fields combined with Dolby Surround sound field.

The combination of Dolby Pro Logic Surround and DSP is used on the sound field program “ PRO LOGIC ENHANCED”.

CINEMA DSP

The YAMAHA “CINEMA DSP” logo indicates these programs that are created by the combination of Dolby Pro Logic and YAMAHA DSP technology.

GETTING STARTED

■ Unpacking

Carefully remove this unit and accessories from the box. You should find the unit itself and the following accessories.

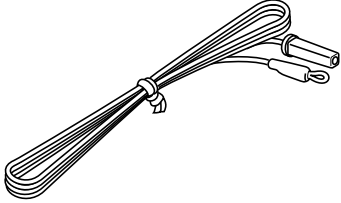
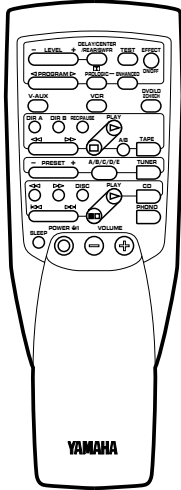
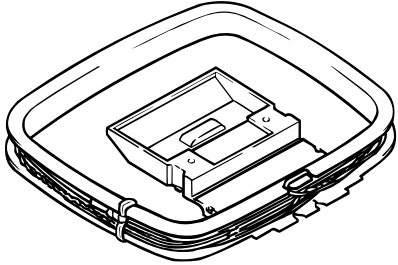
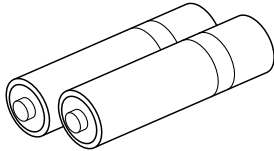
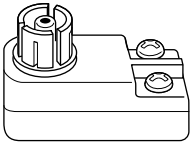
<p>Indoor FM Antenna</p> 	<p>Remote Controller</p> 
<p>AM Loop Antenna</p> 	<p>Batteries (size AA, R6, UM-3)</p> 
<p>75-ohm/300-ohm antenna adapter (U.K. model only)</p> 	

■ Opening and closing the front cover

Close the front cover whenever the controls inside the panel are not used.

To open the front cover

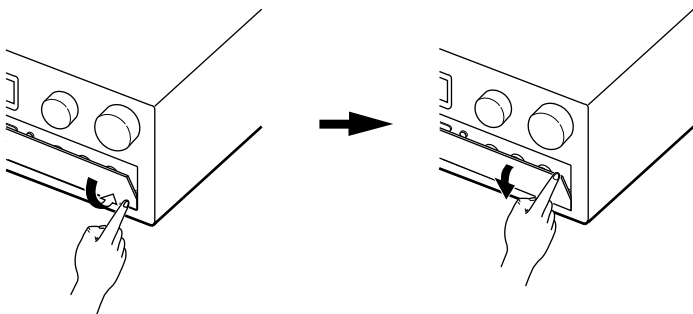

To close the front cover

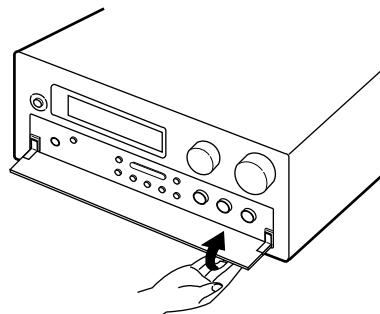

■ Installing batteries in the remote controller

Since the remote controller will be used for many of this unit's control operations, you should begin by installing the supplied batteries.

1. Turn the remote controller over and slide the battery compartment cover in the direction of the arrow.
2. Insert the batteries (R6, AA, UM-3 type) according to the polarity markings on the inside of the battery compartment.
3. Close the battery compartment cover.

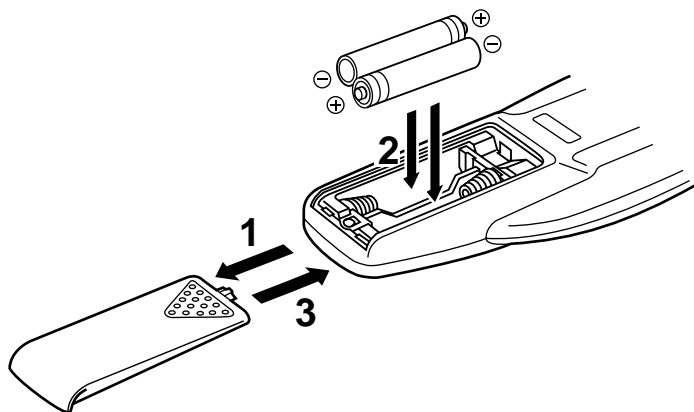

Battery replacement

If you find that the remote controller must be used closer to the main unit, the batteries are weak. Replace both batteries with new ones.

Notes

- Use only AA, R6, UM-3 batteries.
- Be sure the polarities are correct. (See the illustration inside the battery compartment.)
- Remove the batteries if the remote controller is not used for an extended period of time.
- If batteries leak, dispose of them immediately. Avoid touching the leaked material and contact with clothing, etc. Clean the battery compartment thoroughly before installing new batteries.

■ Using the remote controller

Remote controller operation range

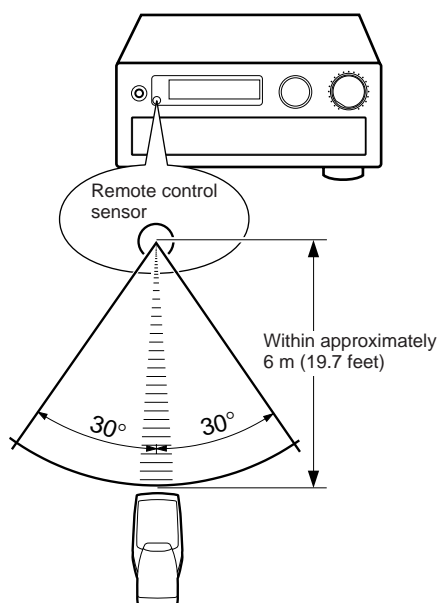

Notes

- The area between the remote controller and the main unit must be clear of large obstacles.
- Do not expose the remote control sensor to strong lighting, in particular, an inverter type fluorescent lamp. Otherwise, the remote controller may not work properly. If necessary, position the main unit away from direct lighting.

SPEAKER SETUP

Speakers to be used

This unit is designed to provide the best sound-field quality with a 5-speaker configuration. The most effective speakers to use with this unit are main speakers, rear speakers, and a center speaker. You can do without the center speaker. (Refer to the “**4-Speaker Configuration**” shown below.)

The main speakers are used for the main source sound. They could be the speakers from your present stereo system. The rear speakers are used for the effect and surround sounds, and the center speaker is for the center sounds (dialog etc.) within programs encoded with Dolby Surround. The center speaker needs to be equal in power to the main speakers, although the rear speakers do not have to be equal. However, all the speakers should have high enough power handling to accept the maximum output of this unit.

Speaker configuration

5-Speaker Configuration

This configuration is the most effective and recommended one. In this configuration, the center speaker is necessary as well as the rear speakers. If the program **PRO LOGIC** or **PRO LOGIC ENHANCED** is selected, conversations will be output from the center speaker and the ambience will be excellent.

- Set the center channel mode to the “**NORMAL**” or “**WIDE**” position. (For details, refer to page 22.)

4-Speaker Configuration

The center speaker is not used in this configuration. If the program **PRO LOGIC** or **PRO LOGIC ENHANCED** is selected, the center sound is output from the left and the right main speakers. However, the sound effect of other DSP programs can be the same as that of the 5-speaker configuration.

- Be sure to set the center channel mode to the “**PHANTOM**” position. (For details, refer to page 22.)

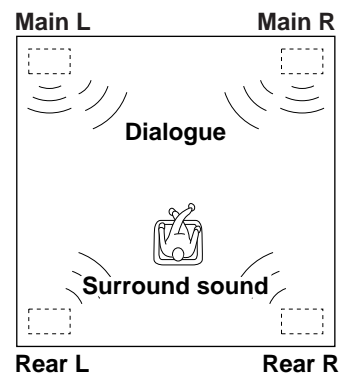
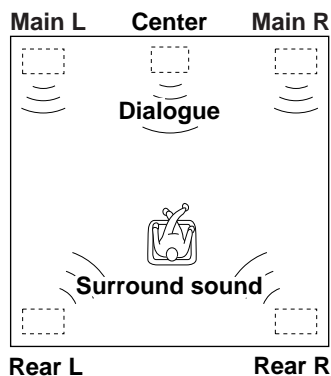

Speaker placement

The recommended speaker configuration, the 5-speaker configuration, will require two speaker pairs: **main speakers** (your normal stereo speakers), and **rear speakers**, plus a **center speaker**. When you place these speakers, refer to the following.

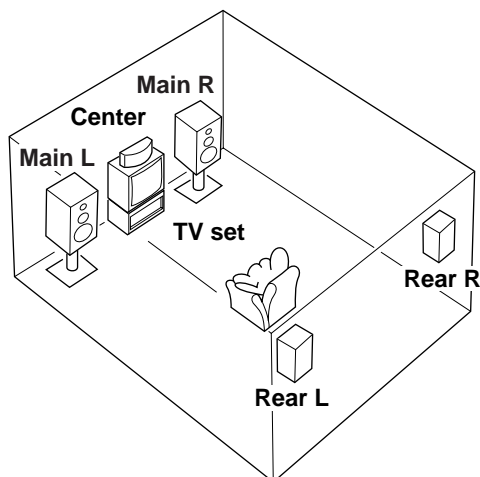

- Main:** The position of your present stereo speaker system.
- Rear:** Behind your listening position, facing slightly inward. Nearly 1.8m (approx. 6 feet) above the floor.
- Center:** Precisely between the main speakers. (To avoid interference with TV sets, use a magnetically shielded speaker.)

CONNECTIONS

Caution: Plug in this unit and other components after all connections are completed.

■ Connecting audio and video components

All connections must be correct, that is to say L (left) to L, R (right) to R, “+” to “+” and “-” to “-”. Also refer to the owner’s manual for each of your components.

* The output (or input) terminals of YAMAHA components numbered as 1, 3, 4, etc. on the rear panel must be connected to the same-numbered terminals of this unit.

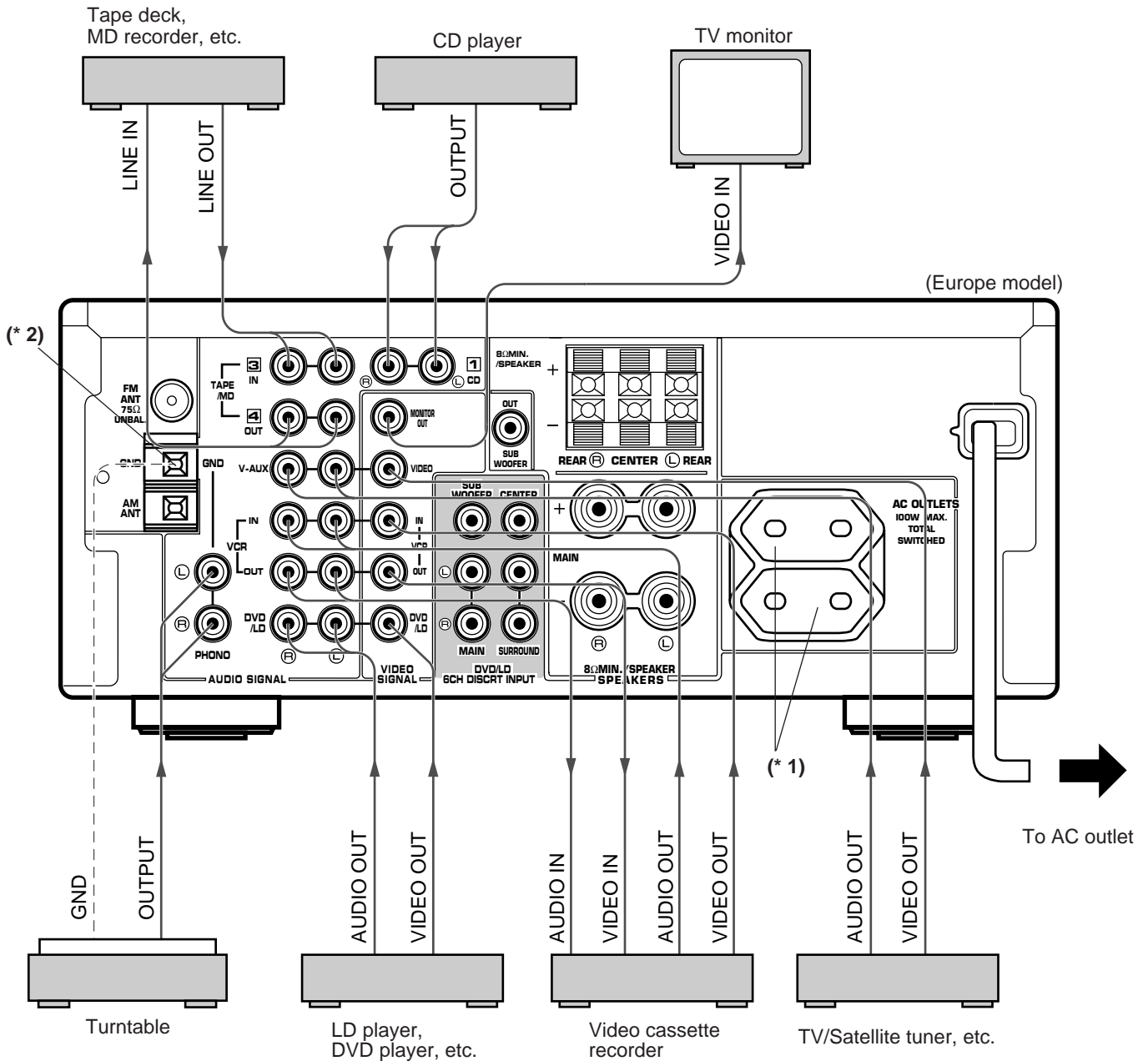

(* 1), (* 2) : See page 10.

ON SCREEN display

If you connect a VCR, LD player, video monitor, etc. to this unit, you can display DSP program names and information about other settings and adjustments on the video monitor screen. Information is superimposed over the video image. If there is no image on the monitor, the information will be displayed over a monochromatic background.

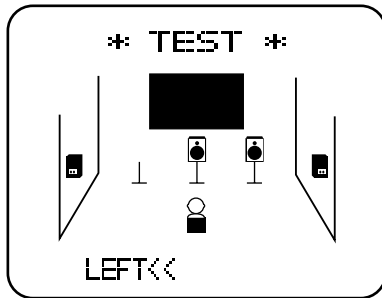

TV MODE PAL/NTSC switch (General model only)

This unit is designed for use with the NTSC and PAL television formats. Set this switch to the position for the format your TV monitor employs.

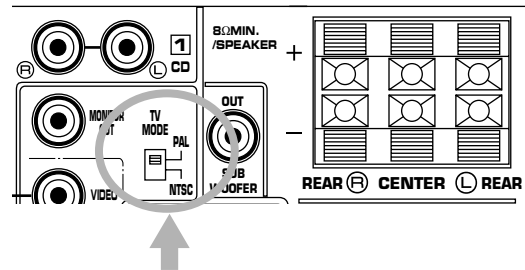

TV MODE PAL/NTSC switch

- PAL:** Set to this position if your TV monitor employs the PAL format.
 * Outputs signals in the PAL format no matter which format (PAL or NTSC) of video signal is sent from an external video unit to this unit.
- NTSC:** Set to this position if your TV monitor employs the NTSC format.
 * Outputs signals in the NTSC format no matter which format (PAL or NTSC) of video signal is sent from an external video unit to this unit.

Note

Be sure to input a video signal which employs the same format that your TV monitor employs, otherwise a picture will not be played back normally.

(* 1):

AC OUTLETS (SWITCHED)

(Europe and General models) 2 SWITCHED OUTLETS
 (U.K. model)..... 1 SWITCHED OUTLET

Use these to connect the power cords of your components to this unit.

The power to the **SWITCHED** outlets is controlled by this unit's **STANDBY/ON** switch or the remote controller's **POWER** ϕ /I key. These outlets will supply power to any component whenever this unit is turned on.

The maximum power (total power consumption of components) that can be connected to the **SWITCHED AC OUTLETS** is 100 watts.

(* 2):

GND terminal (For turntable use)

Connecting the ground wire of the turntable to the **GND** terminal will normally minimize hum, but in some cases better results may be obtained with the ground wire disconnected.

Connecting with 6 channel discrete outputs of a Dolby Digital decoder, DTS decoder or DVD player, etc.

If you have a Dolby Digital decoder, DTS decoder or a DVD player etc. which incorporates a Dolby Digital decoder, DTS decoder or MPEG 2 decoder, its 6 channel discrete outputs can be connected to the DVD/LD 6CH DISCRT INPUT terminals of this unit.

An example of connections:

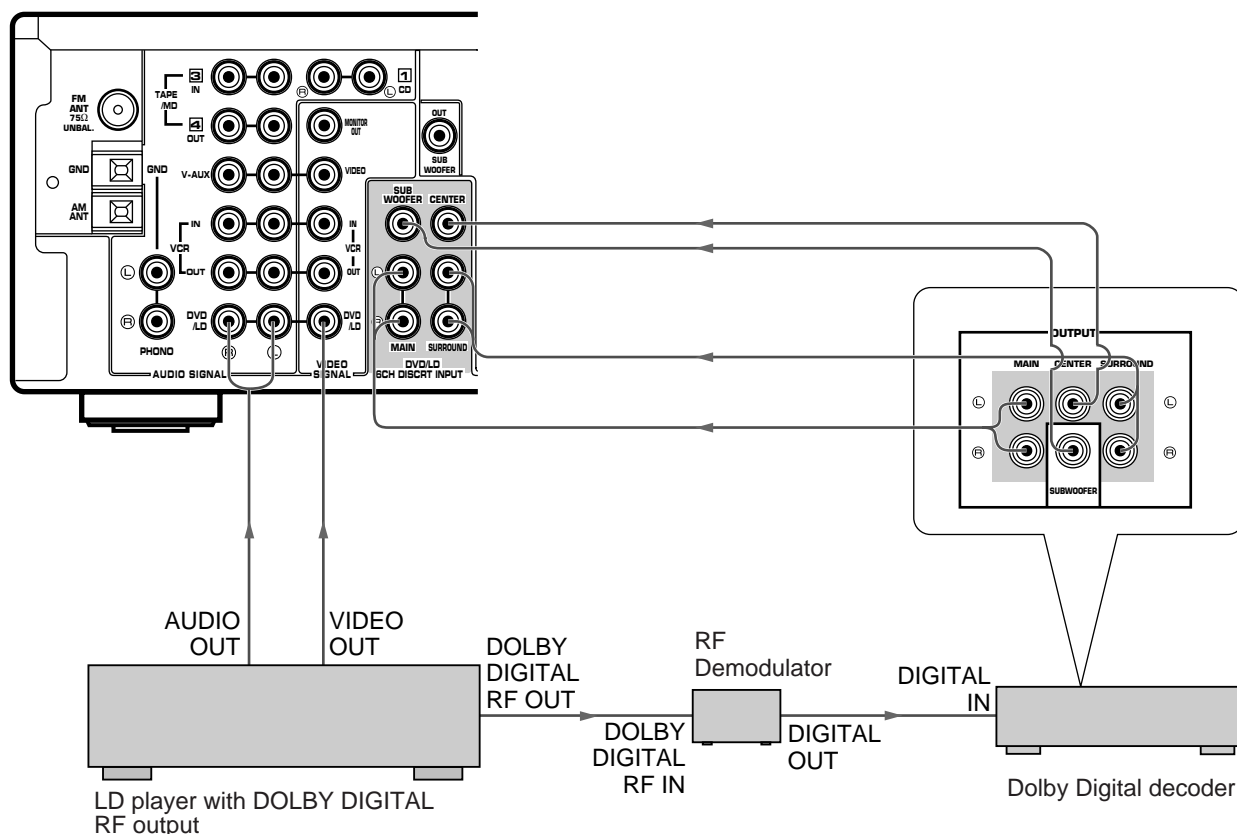

Notes

- The LD or DVD player must be also connected to the DVD/LD AUDIO SIGNAL input terminals of this unit for playing a source with Dolby Pro Logic Surround decoded or in 2-channel stereo (or monaural).
- The discrete signals input to this unit cannot be recorded by a tape deck, MD recorder or VCR. To record a source played on the LD or DVD player, it must be connected to the DVD/LD AUDIO/VIDEO SIGNAL input terminals of this unit.
- If you made no connection to the SUBWOOFER input terminal of this unit or you will not use a subwoofer, you must make a setting on the Dolby Digital decoder etc. so that signals at the SUBWOOFER channel are distributed to the right and left MAIN output terminals of the Dolby Digital decoder etc. For details, refer to the owner's manual for the Dolby Digital decoder etc.

■ Connecting speakers

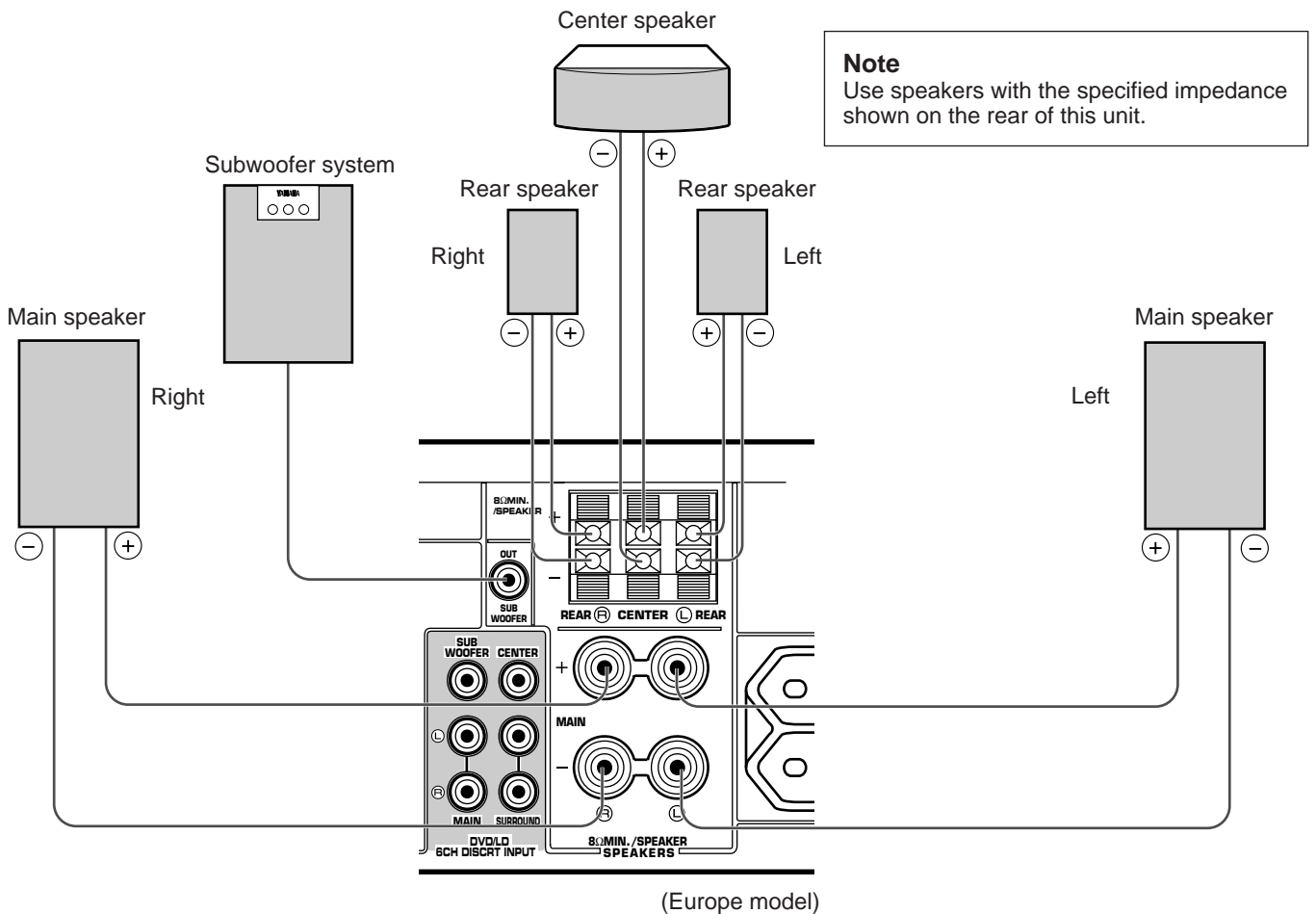

How to Connect:

Connect the **SPEAKERS** terminals to your speakers with the wire of the proper gauge (keep as short as possible). If the connections are faulty, no sound will be heard from the speakers. Make sure that the polarity of the speaker wires is correct. That is the + and – markings are observed. If these wires are reversed, the sound will be unnatural and lack bass.

Caution

Do not let the bare speaker wires touch each other or any metal part of this unit. This could damage this unit or the speakers, or both.

For connecting to the MAIN SPEAKERS terminals

Red: positive (+)
Black: negative (–)

<General model only>

Banana Plug connections are also possible. Simply insert the Banana Plug connector into the corresponding terminal.

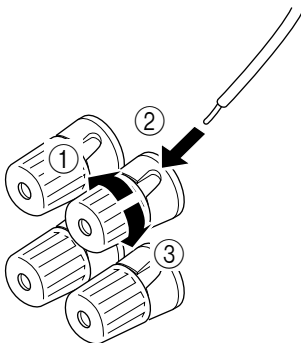

- ① Loosen the knob.
- ② Insert the bare wire.
[Remove approx. 5mm (1/4") insulation from the speaker wires.]
- ③ Tighten the knob and secure the wire.

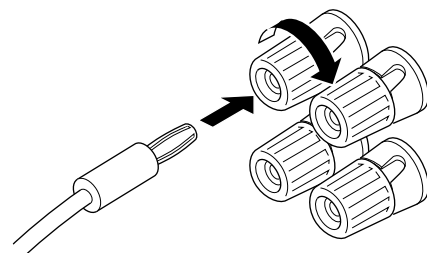

For connecting to the REAR and CENTER SPEAKERS terminals

Red: positive (+)
Black: negative (-)

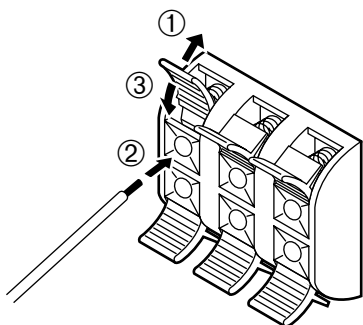

- ① Press the tab.
- ② Insert the bare wire.
[Remove approx. 5mm (1/4") insulation from the speaker wires.]
- ③ Release the tab and secure the wire.

Note on a subwoofer connection:

You may wish to add a subwoofer to reinforce low frequencies or to output low bass sound from the subwoofer channel when reproducing discrete signals.

When using a subwoofer, connect the SUBWOOFER OUT terminal of this unit to the INPUT terminal of the subwoofer amplifier, and connect the speaker terminals of the subwoofer amplifier to the subwoofer.

With some subwoofers, including the Yamaha Active Servo Processing Subwoofer System, the amplifier and subwoofer are in the same unit. Such a subwoofer needs only the connection between the SUBWOOFER OUT terminal of this unit and the INPUT terminal of the subwoofer.

SUBWOOFER OUT terminal

This terminal is for connecting with the input terminal of an amplifier for driving a subwoofer.

When the input signals to this unit are normal 2-channel stereo, this terminal outputs low frequencies from the main and center channels. (The frequency cut-off of this terminal is at 150 Hz.) When the source equipment connected to the DVD/LD 6CH DISCRT INPUT terminals of this unit is selected as the input source, this terminal outputs signals from the subwoofer channel.

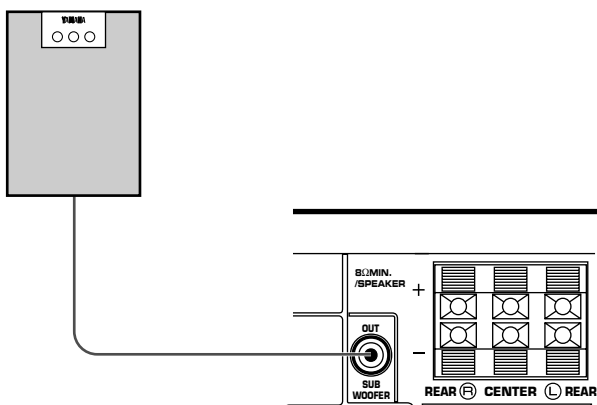

■ Connecting antennas

- Each antenna should be connected to the designated terminal(s) correctly, as shown in the following figure.
- Both AM and FM indoor antennas are included with this unit. In general, these antennas will provide sufficient signal strength. Nevertheless, a properly installed outdoor antenna will give clearer reception than an indoor one. If you experience poor reception quality only with the indoor antennas, the use of an outdoor antenna may result in improvement.

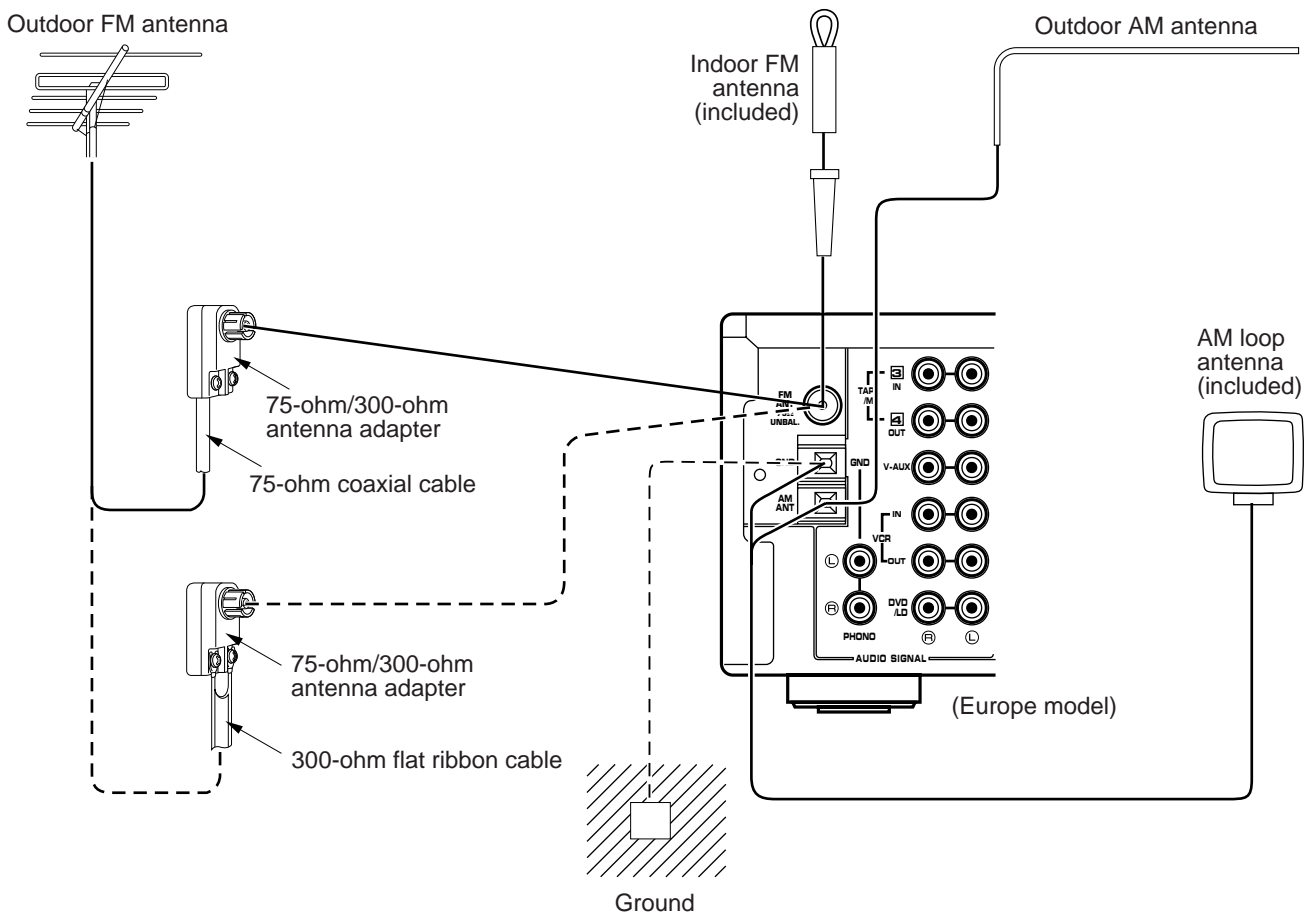

Connecting the AM loop antenna

1. Press the tab and unlock the terminal hole.
2. Connect the AM loop antenna lead wires to the AM ANT and GND terminals.
3. Return the tab back to the original position to lock the lead wires. Lightly pull on the lead wires to confirm a good connection.

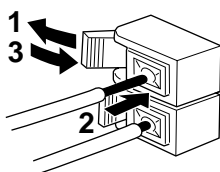

4. Attach the loop antenna to the antenna stand.

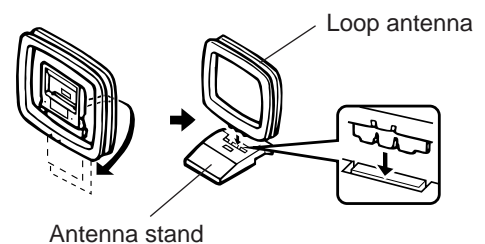

5. Orient the AM loop antenna so that the best reception is obtained.

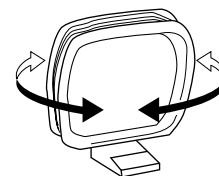

Notes

- The AM loop antenna should be placed apart from the main unit. The antenna may be hung on a wall.
- The AM loop antenna should be kept connected, even if an outdoor AM antenna is connected to this unit.

Connecting the indoor FM antenna

Connect the included indoor antenna to the 75Ω UNBAL. FM ANT terminal.

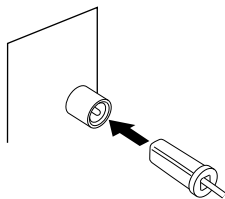
**Note**

Do not use an outdoor FM antenna and the indoor FM antenna at the same time.

GND terminal

For maximum safety and minimum interference, connect the **GND** terminal to a good ground. A good ground is a metal stake driven into moist earth.

Optional outdoor AM antenna

If this unit is placed in steel buildings or an area far from broadcasting stations, it may be necessary to install an outside long wire antenna.

Optional outdoor FM antenna

Consult your dealer or authorized service center about the best method of selecting and erecting an outdoor FM antenna.

The choice of the flat ribbon cable is also important. Flat ribbon cable performs well electrically, and is cheaper and somewhat easier to handle when routing it through windows and around rooms. Coaxial cable is more expensive, does a much better job of minimizing interference, is less prone to the effects of weather and close-by metal objects, and is nearly as good a signal conductor as flat ribbon cable. Coaxial cable is somewhat more difficult to install at the point where the cable enters the building. If coaxial cable is selected, make sure the antenna is designed to be used with this type of cable.

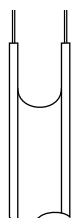

300-ohm flat ribbon cable

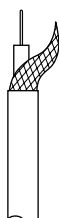

75-ohm coaxial cable

* Use a 75-ohm/300-ohm antenna adapter (not included) or a 75-ohm antenna adapter (not included) for connections.

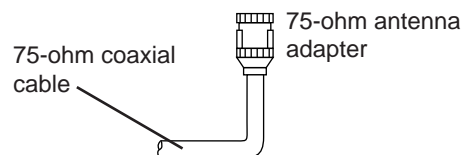
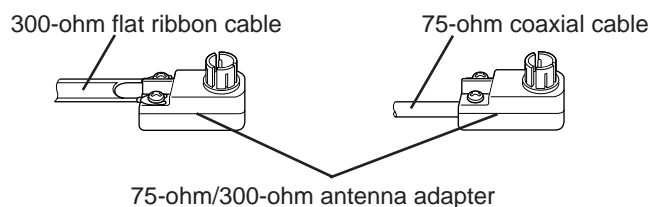
**Notes for FM antenna installation**

- To minimize the influence of automobile ignition noise, locate the antenna as far from heavy traffic as possible.
- Keep the flat ribbon cable or coaxial cable as short as possible. Do not bundle or roll up an excess of the cable.
- The antenna should be at least two meters (6.6 feet) from reinforced concrete walls or metal structures.

CONTROLS AND THEIR FUNCTIONS

■ Front panel

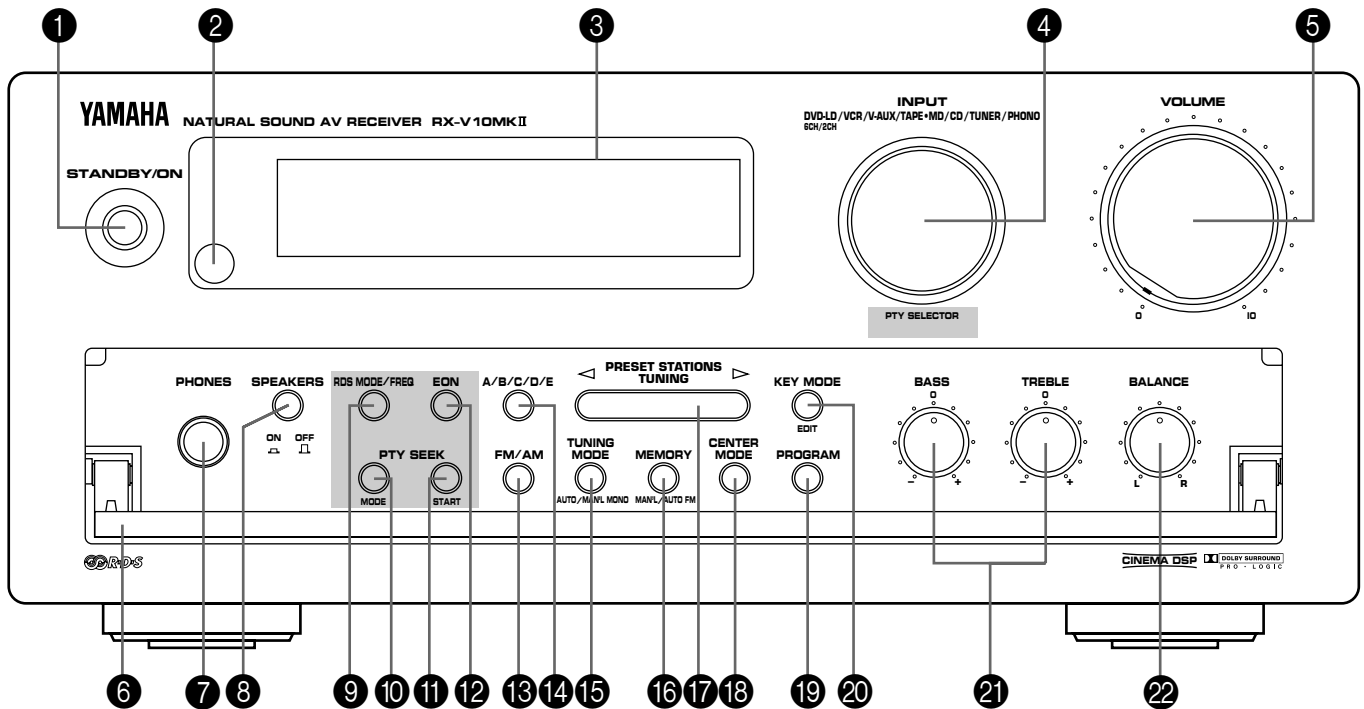

Parts in the shaded areas are provided for Europe and U.K. models only.

1 STANDBY/ON switch

Press this switch to turn on the power. Press this switch again to set this unit in the standby mode.

Standby mode

This unit is still using a small amount of power in this mode in order to be ready to receive infrared-signals from the remote controller.

2 Remote control sensor

Receives signals from the remote controller.

3 Display panel

Displays a variety of information. (Refer to page 20 for details.)

4 INPUT selector

Turn this knob to select the input source.
The selected source will be shown on the display.

PTY SELECTOR

<Europe and U.K. models only>

When this unit is in the PTY SEEK mode, tuning this control changes the currently selected program type.

5 VOLUME control

Used to raise or lower the volume level.

6 Front cover

Refer to page 6 on how to open and close the front cover.

7 PHONES jack

Headphones can be plugged into this jack for private listening. Only the sound signals from the main channels are output. When listening with headphones privately, set the **SPEAKERS** switch to the **OFF** position.

PHONES

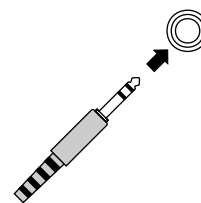

8 SPEAKERS switch

Press and set this switch inward (**ON**) to make the all speakers and a subwoofer produce a sound.

Press and release this switch outward (**OFF**) to make the all speakers and a subwoofer produce no sound.

9 RDS MODE/FREQ button**<Europe and U.K. models only>**

When an RDS station is received, pressing this button changes the display mode into the PS mode, PTY mode, RT mode, and frequency display in turn.

10 PTY SEEK MODE button**<Europe and U.K. models only>**

Turns the unit into the PTY SEEK mode.

11 PTY SEEK START button**<Europe and U.K. models only>**

Begins searching for a station after the desired program type is selected in the PTY SEEK mode.

12 EON button**<Europe and U.K. models only>**

Selects the desired program type (NEWS, INFO, AFFAIRS, SPORT) when you want to call a radio program of the program type automatically.

13 FM/AM button

Press this button to switch the reception band between FM and AM.

14 A/B/C/D/E button

Press this button to select a group (A to E) of preset stations.

15 TUNING MODE (AUTO/MAN'L MONO) button

Press this button to switch the tuning mode between automatic and manual. To select the automatic tuning mode, press this button so that the "AUTO" indicator is illuminated on the display. To select the manual tuning mode, press this button so that the "AUTO" indicator is not illuminated.

16 MEMORY (MAN'L/AUTO FM) button

Use this button to enter a station to memory. Refer to the section "Manual preset tuning" on page 28 for details. Hold down this button for more than 3 seconds to start automatic preset tuning. Refer to page 29 for details.

17 PRESET STATIONS/TUNING button

This button is used for the **PRESET STATIONS** function when "PRESET" is illuminated on the display, and the **TUNING** function when "PRESET" is not illuminated. The following explains these functions in detail.

PRESET STATIONS :

Selects a preset station number (from 1 to 8).

Press the \triangleright side to select a higher preset station number.

Press the \triangleleft side to select a lower preset station number.

TUNING :

Used for tuning. Press the \triangleright side to tune in to a higher frequency, and press the \triangleleft side to tune in to a lower frequency.

18 CENTER MODE button

Selects a center channel output mode (NORMAL, WIDE or PHANTOM). (For details, refer to page 22.)

19 PROGRAM button

When this button is repeatedly pressed, the built-in digital sound field processor turns on, then the selected DSP program changes to another program one by one, then the digital sound field processor turns off, and repeated.

20 KEY MODE/EDIT button

Press this button to alternately illuminate and turn off "PRESET" on the display panel. This button switches the function of the **PRESET STATIONS/TUNING** button. This button is also used to exchange the places of two preset stations with each other.

21 Tone controls

These controls are effective only for the sound from the main speakers.

BASS

Used to increase or decrease the low frequency response.

The 0 position produces flat response.

TREBLE

Used to increase or decrease the high frequency response.

The 0 position produces flat response.

22 BALANCE control

This knob controls the sound from the main speakers only. The balance of the output volume to the left and right main speakers can be adjusted to compensate for sound imbalances caused by the speaker location or listening room conditions.

Remote controller

The remote controller provided with this unit is designed to control the most commonly used functions. If the CD player or tape deck is a YAMAHA component with remote control compatibility, this remote controller will also control various functions.

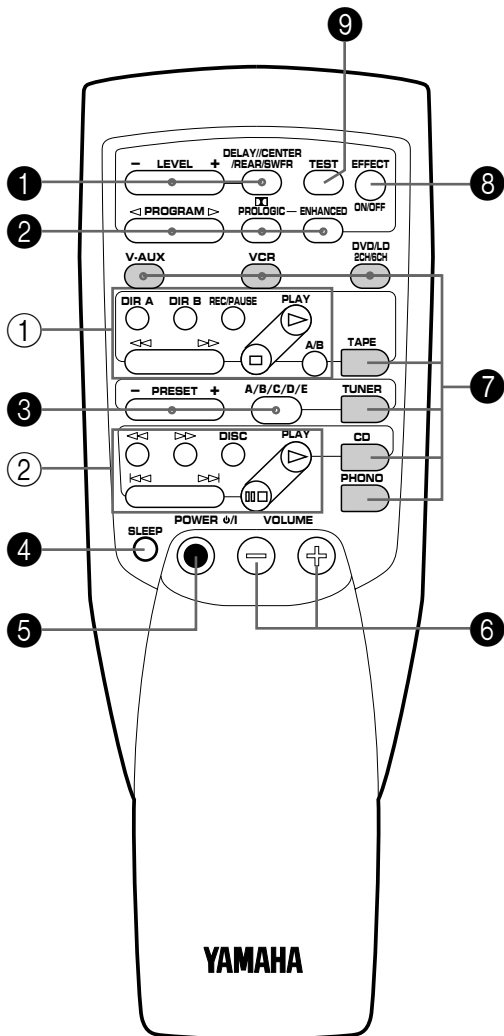

For Control of This Unit

1 DELAY/CENTER/REAR/SWFR and LEVEL +/- keys

Adjust the delay time (DELAY), the center channel output level (CENTER), the rear channel output level (REAR) and the output level to the SUBWOOFER OUT terminal (SWFR). Select the item which you want to adjust by pressing the **DELAY/CENTER/REAR/SWFR** key and adjust its time or level by pressing the **LEVEL +/-** key.
(For details, refer to pages 23, 26, 38 and 39.)

2 Program selector keys

PROGRAM:

When the built-in digital sound field processor (including the Dolby Pro Logic Surround decoder) is on, this key changes the currently selected DSP program each time the right or left side of this key is pressed.

PROLOGIC:

Directly selects the **PRO LOGIC** program.

ENHANCED:

Directly selects the **PRO LOGIC ENHANCED** program.

3 Tuner keys

Control tuners.

+: Press this key to select the next preset station number.

-: Press this key to select the previous preset station number.

A/B/C/D/E: Selects the group (A to E) of preset station numbers.

4 SLEEP timer key

This unit is automatically set in the standby mode one hour after this key is pressed (so that the "SLEEP" indicator is illuminated). To cancel this function, press this key again so that the "SLEEP" indicator turns off.

5 POWER ϕ /I key

Turns on the power of this unit and sets this unit in the standby mode alternately.

6 VOLUME +/- keys

Press these keys to increase or decrease the volume.

7 Input selector keys

Press a key to select the input source.

When the DVD/LD input source is selected, pressing the **DVD/LD** key switches the input signals between 2 channel stereo signals and 6 channel discrete signals. When switched to "6ch", discrete signals from the unit connected to the DVD/LD 6CH DISCRT INPUT terminals of this unit are selected as the input signals.

8 EFFECT ON/OFF key

Press this key to turn on/off the digital sound field processor, which includes the Dolby Pro Logic Surround decoder.

9 TEST key

This key is used when adjusting the speaker balance. (Refer to pages 21 to 23.)

For Other Component Control

Identify the remote controller keys with your component's keys. If these keys are identical, their functions will be the same. On each key function, refer to the corresponding instruction on your component's manual.

① Tape deck keys

Control tape decks.

- * The **DIR A, B** and **A/B** keys apply only to double cassette tape decks.
- * Pressing the **DIR A** key will reverse the tape direction on a single cassette tape deck with the automatic reverse function.

② CD player keys

Control compact disc players.

- * The **DISC** is used for compact disc changers.

■ Display panel

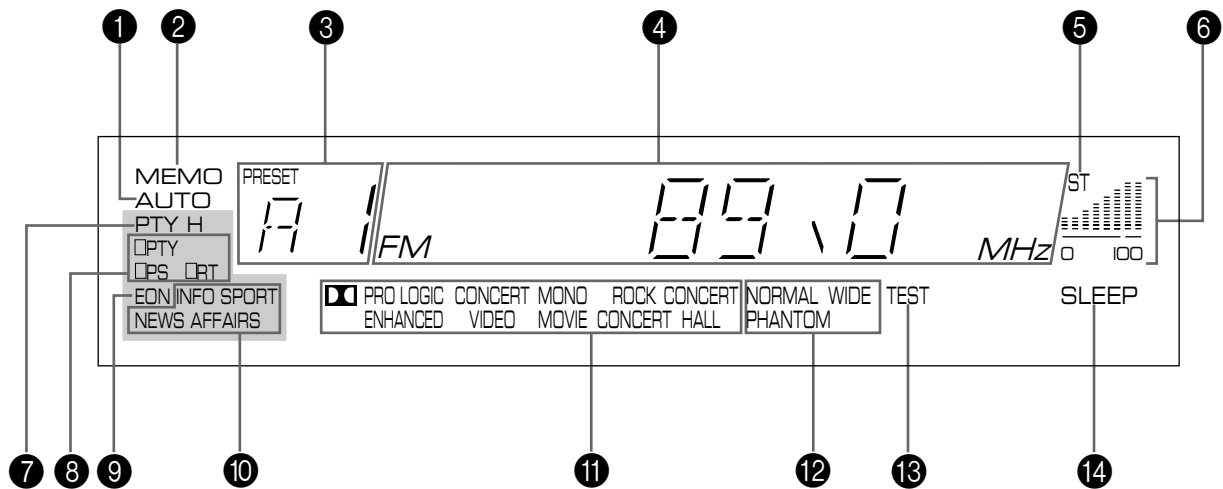

Indicators in the shaded areas are provided for Europe and U.K. models only.

1 AUTO indicator

This indicator will be illuminated during the automatic tuning mode.

2 MEMO indicator

A flashing **MEMO** indicator means a station can be saved, as explained in the following:

Press the **MEMORY** button. The **MEMO** indicator will flash about 5 seconds. While the indicator is flashing, program the displayed station to memory by using the **A/B/C/D/E** and **PRESET STATIONS/TUNING** buttons.

3 Preset station number indicator

Shows the selected group (A to E) and preset station number (1 to 8).

4 Multi-information display

This display shows the status of adjustments and setting changes. Several statuses can be viewed at one time. The current station frequency and band (AM or FM) will also appear when the tuner source input mode is selected.

5 STEREO indicator

This indicator will be illuminated when an FM stereo broadcast with sufficient signal strength is received.

6 Signal-level meter

Indicates the signal level of the received station. If multipath interference is detected, the indication decreases.

7 PTY H (HOLD) indicator <Europe and U.K. models only>

This indicator will be illuminated while the search is performed in the PTY SEEK mode.

8 RDS mode indicators <Europe and U.K. models only>

The name(s) of RDS mode(s) employed by the currently received RDS station will be illuminated. Illumination of the indicator on the head of a name shows that the corresponding RDS mode is now selected.

9 EON indicator <Europe and U.K. models only>

This indicator will be illuminated when an RDS station that employs the EON data service is received.

10 Program type name indicators <Europe and U.K. models only>

The name selected in the EON mode will be illuminated.

11 DSP program indicators

The name of the selected DSP program will be illuminated when the built-in digital sound field processor or the Dolby Pro Logic Surround decoder, or both of them are on.

12 Center channel mode indicators

The name of the selected center channel mode (NORMAL, WIDE or PHANTOM) will be illuminated only when the **PRO LOGIC** or **PRO LOGIC ENHANCED** program is selected.

13 TEST indicator

Flashes when the built-in test tone generator is functioning (when the test-tone is output from speakers).

14 SLEEP indicator

This indicator will be illuminated when the built-in SLEEP timer is functioning.

SPEAKER BALANCE ADJUSTMENT

This procedure lets you adjust the sound output level balance between the main, center, and rear speakers using the built-in test tone generator. After the adjustments, the sound output level heard at the listening position will be the same from each speaker. This is important for the best performance of the digital sound field processor and the Dolby Pro Logic Surround decoder. **The adjustment of each speaker output level should be done at your listening position with the remote controller.**

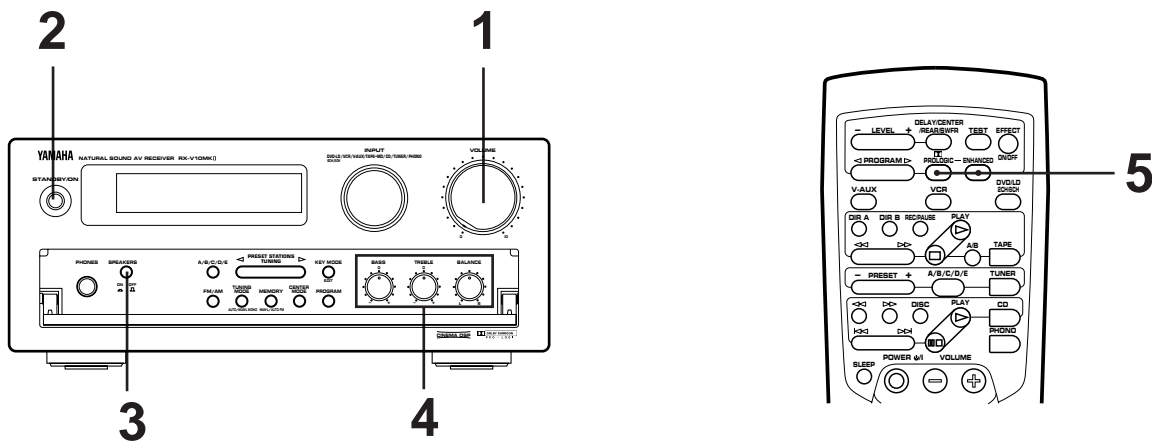

1

Set to the "0" position.

4

Set to the "0" position.

2 Turn on the power.

5 Select the PRO LOGIC or PRO LOGIC ENHANCED program, so that the corresponding name is illuminated on the display.

3 Make sure that the **SPEAKERS** switch is set to the **ON** position. If it is not so, press and set the **SPEAKERS** switch inward (**ON**).

CONTINUED

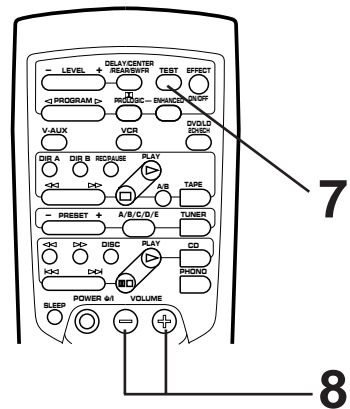
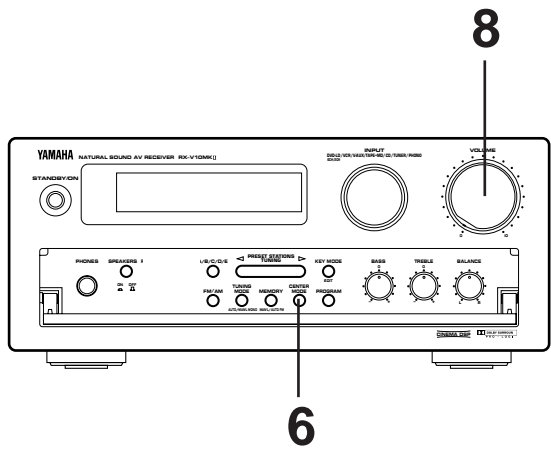

6 Select the center channel output mode suitable for your speaker configuration. (Refer to “**Speaker configuration**” on page 8.)

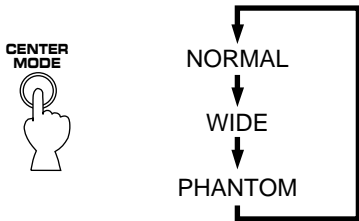

For the feature of each mode, refer to the “**Note**” shown below.

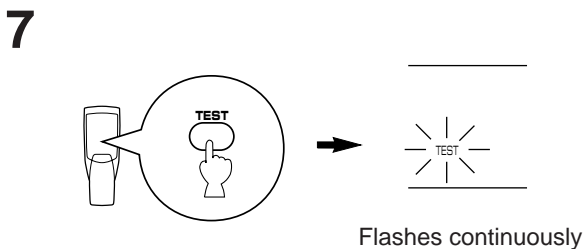

Note
In step 6, when you select a center channel output mode, note the following.

For 5-speaker configuration

NORMAL: Select this mode when you use a center speaker that is smaller than the main speakers. In this mode, the bass tone will be output from the main speakers.

WIDE: Select this mode when you use the center speaker approximately same sized as the main speakers.

For 4-speaker configuration

PHANTOM: Select this mode when you do not use the center speaker. The center sound will be output from the left and right main speakers.

8 Turn up the volume.

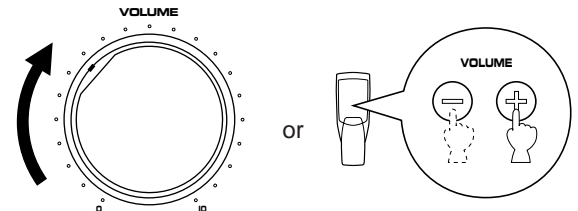

You will hear a test tone (like pink noise) from the left main speaker, then the center speaker, then the right main speaker, and then the rear speakers, for about two seconds each. The display changes as shown below.

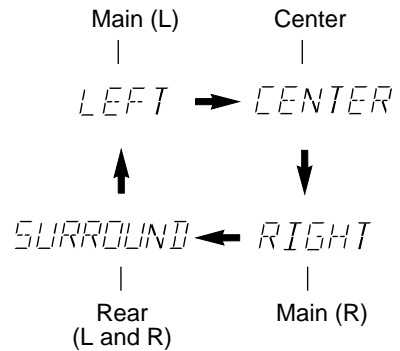

- * The test tone from the left rear speaker and the right rear speaker will be heard at the same time.
- * The state of the test tone output is also shown on the monitor screen by an image of the audio listening room. This is convenient for adjusting each speaker level.

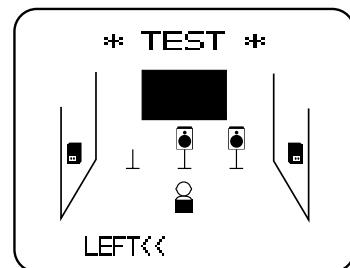

CONTINUED

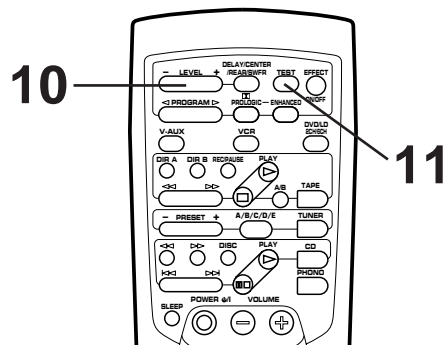
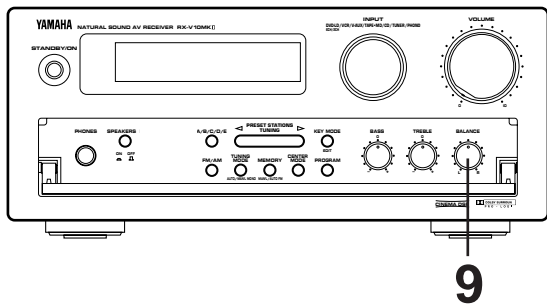

9 Adjust the **BALANCE** control so that the effect sound output level of the left main speaker and the right main speaker are the same.



10 Adjust the sound output levels of the center speaker and the rear speakers by using the **LEVEL** key so that they become almost the same as the main speakers.

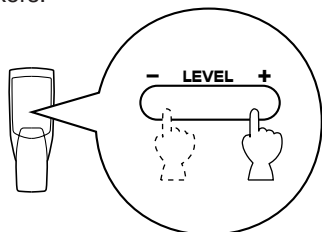

- When the test tone is output from the center speaker, pressing the **LEVEL** key changes the output level of the center speaker.



Adjustable

- When the test tone is output from the rear speakers, pressing the **LEVEL** key changes the output level of the rear speakers.

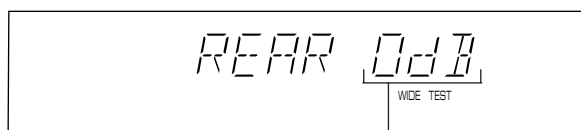

Adjustable

* Pressing the + side raises and the - side lowers the level.

11 Cancel the test tone.

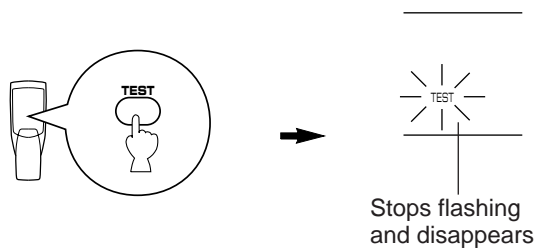

Notes

- Once you have completed these adjustments, you can adjust the sound level on your audio system by using the **VOLUME** control (or the **VOLUME** keys on the remote controller) only.
- If you use external power amplifiers, you may also use their volume controls to obtain proper balance.
- In step 6, if the center channel mode is in the "PHANTOM" position, the sound output level of the center speaker cannot be adjusted. This is because in this mode, the center sound is automatically output from the left and right main speakers.

From pages 24 to 39, this manual describes how to operate this unit mainly by using the front panel control parts. To operate this unit on the remote controller, use the corresponding keys on the remote controller.

PLAYING AND RECORDING A SOURCE

■ Playing a source

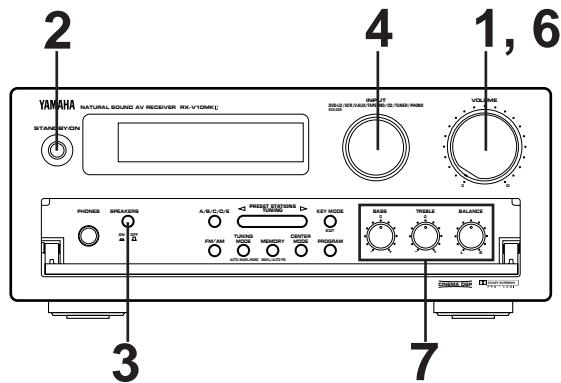

1

Set to the "0" position.

2 Turn on the power.

3 Make sure that the **SPEAKERS** switch is set to the **ON** position. If it is not so, press and set the **SPEAKERS** switch inward (**ON**).

4 Select the desired input source by turning the **INPUT** selector so that the name of the source appears on the display. (For video sources, turn on the TV monitor.)

5 Play the source. (Refer to page 28 for details on tuning.)

6

Adjust the output level.

7 Adjust the **BASS**, **TREBLE** and **BALANCE** controls (refer to page 26), and use the digital sound field processor. (Refer to page 36.)

Note
The **INPUT** selector selects the source connected to the input terminals on the rear panel whose name is identical with the name shown on the display.

When you finish using this unit
Press the **STANDBY/ON** switch on the front panel again or the **POWER** ϕ /I key on the remote controller to enter the standby mode.

To listen to a decoded source using Dolby Digital or DTS by reproducing the signals input to the DVD/LD 6CH DISCRT INPUT terminals of this unit.

In step 4, turn the **INPUT** selector on the front panel or press the **DVD/LD (2CH/6CH)** key on the remote controller repeatedly until “DVD 6ch” appears on the display.

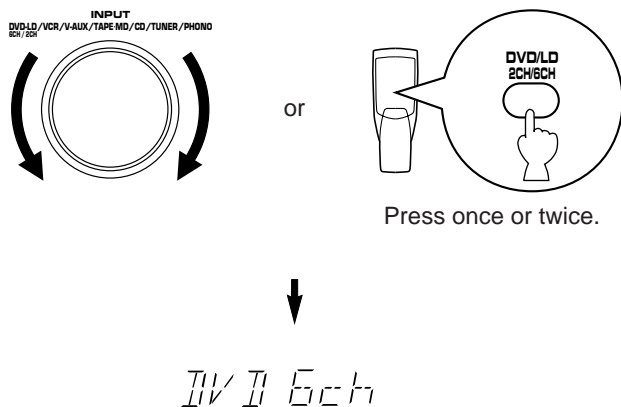

To cancel listening to a decoded source using Dolby Digital or DTS

Select another input source.

Note for reproducing discrete signals with Dolby Digital or DTS decoded:

1. Your speaker system must include a center speaker.
2. Your speaker system may include a subwoofer.
 - * Connect a subwoofer which has a built-in amplifier to the SUBWOOFER OUT terminal of this unit.
 - * You can do without using a subwoofer. If you do so, you must set the Dolby Digital Decoder etc. so that signals at the subwoofer channel are distributed to the right and left MAIN output terminals.
 For details, refer to the owner's manual for the Dolby Digital Decoder etc.

Notes

- When you switch to the “6ch” mode, the built-in Digital Sound Field processor will not work and adjustment of delay time cannot be made.
- Switching this unit to the “6ch” mode will input no signal to this unit if there is no connection to the DVD/LD 6CH DISCRT INPUT terminals of this unit.

Recording a source to tape (or MD)

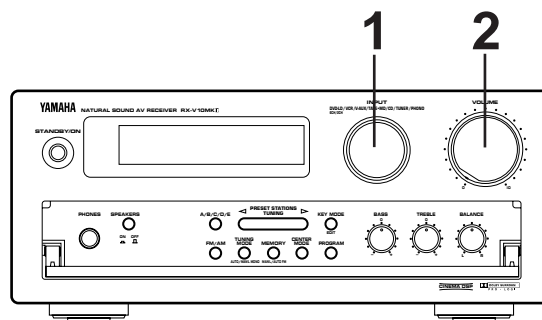

- 1 Select the source to be recorded.

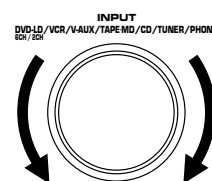

- 2 Play the source and then turn the **VOLUME** control up to confirm the input source. (Refer to the page 27 for details on tuning.)

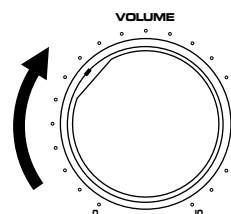

- 3 Begin recording to the tape deck (or MD recorder etc.) or VCR connected to this unit.

Notes

- The settings of DSP and the **VOLUME, BASS, TREBLE** and **BALANCE** controls have no effect on the material being recorded.
- In step 1, do not make an input source selection so that “DVD 6ch” appears in the display. Signals input to this unit's DVD/LD 6CH DISCRT INPUT terminals cannot be recorded by a tape deck (or MD recorder) or VCR.

■ Sound control

Adjusting the BALANCE control

Adjust the balance of the output volume to the left and right speakers to compensate for sound imbalance caused by speaker location or listening room conditions.

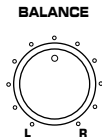

Note

This control is effective only for the sound from the main speakers.

Adjusting the BASS and TREBLE controls

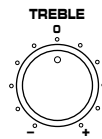
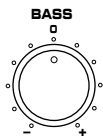

BASS : Turn this knob clockwise to increase (or counter-clockwise to decrease) the low frequency response.

TREBLE : Turn this knob clockwise to increase (or counter-clockwise to decrease) the high frequency response.

Note

These controls are effective only for the sound from the main speakers.

Adjusting the subwoofer output level

If your audio system includes a subwoofer, and an amplifier driving the subwoofer (or a subwoofer system including an amplifier) is connected to the SUBWOOFER OUT terminal on the rear of this unit, you can adjust the subwoofer output level on this unit.

Adjustment can be made only by using the remote controller.

- 1 Press the **DELAY/CENTER/REAR/SWFR** key repeatedly until "SWFR" appears in the display.

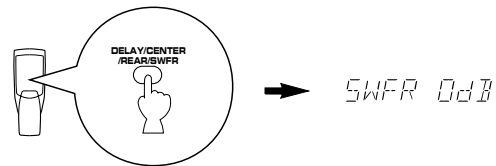

- 2 By continuously pressing the "+" or "-" side of the **LEVEL** button, the level value changes continuously. If you feel that bass tone is insufficient, increase the level, and if you feel that bass tone is overly emphasized, decrease the level.

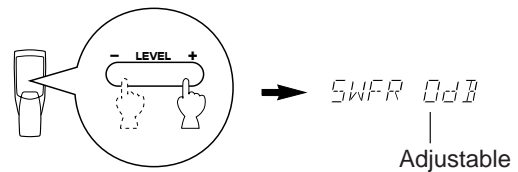

Control range: MIN, -20 to 0 dB

BASIC TUNING OPERATION

Quick automatic-search tuning (automatic tuning) is effective when the station signals are strong with no interference. However, manual tuning can be used during less-than-ideal conditions.

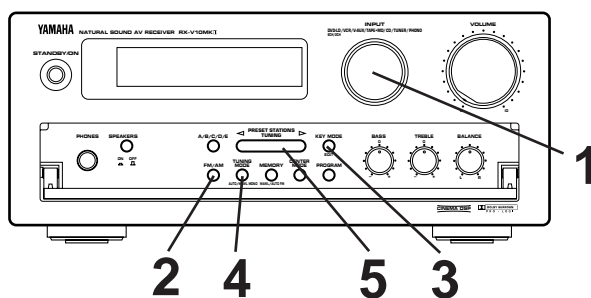

Automatic tuning

- 1** Select "TUNER" as the input source.
- 2** Select the reception band. "FM" or "AM" will be illuminated.
- 3** If "PRESET" is illuminated on the display, then press the **KEY MODE** button to turn it off.
- 4**
- 5** Press the \blacktriangleright side once to tune to a higher frequency. Press the \blacktriangleleft side once to tune to a lower frequency.

* Press the button again if the tuning search does not stop at the correct station.
 * Use manual tuning if the tuning search does not stop at the correct station because the signals are weak.

Manual tuning

- 1** Select "TUNER" as the input source.
- 2** Select the reception band. "FM" or "AM" will be illuminated.
- 3** If "PRESET" is illuminated on the display, then press the **KEY MODE** button to turn it off.
- 4**

Turn the "AUTO" indicator off.
- 5** Tune to the desired station manually.

* Hold down the button to continue the tuning search.

Notes

- Manually selecting an FM station will automatically change the reception to monaural to increase the signal quality.
- **<Europe and U.K. models only>**
 When tuned in to a station, the frequency of the station is shown on the display. If an RDS station that employs PS data service is received, the frequency is then replaced by the station name. Refer to page 33 for details.

PRESET TUNING



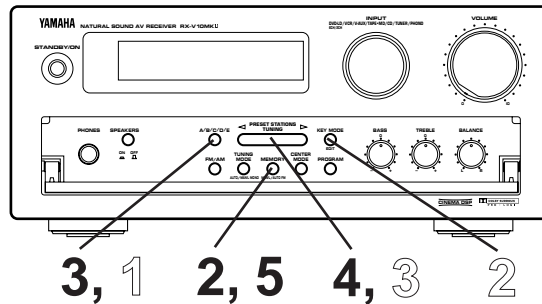

Manual preset tuning

This unit can store station frequencies selected by the tuning operation. With this function, you can recall any desired station only by selecting the preset station number. Up to 40 stations (8 stations x 5 groups) can be stored.



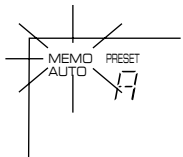

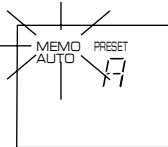
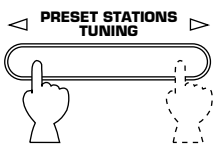
To store stations

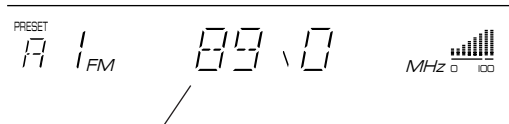
To recall a preset station

- 1 Tune in to a station.
(Refer to the previous page for the tuning procedure.)
- 2  → 
Flashes on and off for about 5 seconds.
- 3  → 
Select a group (A to E) of preset stations before the "MEMO" indicator goes off. The group will appear on the display.
- 4 
Select a preset station number (1 to 8) where you want to program the station before the "MEMO" indicator goes off.
- 5 
Press the **MEMORY** button before the "MEMO" indicator goes off.

Shows the displayed station has been programmed to A1.

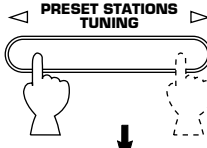
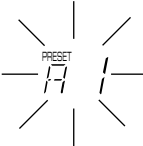
* In the same way, program other stations to A2, A3 ... A8.
* You can program more stations to preset station numbers of other groups in the same way by selecting other groups in step 3.

- 1 Select the group of preset stations.

- 2 "PRESET" must be illuminated on the display to recall preset stations. If necessary, press the **KEY MODE** button.

- 3 Select the preset station number.

↓

Notes

- A new setting can be programmed in place of the former one.
- For presets, the setting of the reception mode (stereo or monaural) is stored along with the station frequency.

Memory back-up

The memory back-up circuit prevents the programmed data from being lost even if this unit is set to the standby mode or the power plug is disconnected from the AC outlet or the power is cut due to a temporary power failure. If, however, the power is cut for more than one week, the memory may be deleted. If so, it can be re-programmed by simply following the PRESET TUNING steps.

Automatic preset tuning

You can make use of an automatic preset tuning function for FM stations. With this function, this unit performs automatic tuning and stores FM stations with strong signals sequentially. Up to 40 stations are stored automatically in the same way as in the manual preset tuning method on page 28.

* <Europe and U.K. models only>

Only RDS stations can be stored by this function.

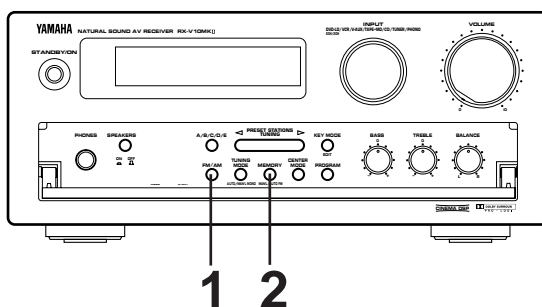

To store stations

1

2

Press and hold for about 3 seconds.

Flashes.

The automatic preset tuning begins from A1. Received stations are programmed to A1, A2 ... A8 sequentially.

* If more than 8 stations are received, they are also programmed to the preset station numbers on other groups (B, C, D and E) in that order.

When the automatic preset tuning is finished

The display shows the frequency of the last preset station. Check the contents and the number of preset stations by following the procedure of the section "To recall a preset station" on page 28.

To recall a preset station

Simply follow the procedure of the section "To recall a preset station" on page 28.

* <Europe and U.K. models only>

A recalled station is shown by the frequency or station name on the display.

Notes

- You can replace a preset station by another FM or AM station manually by simply following the procedure of the section "To store stations" on page 28.
- <General model only>**
- If the number of received stations is not enough to be stored up to E8, the search will be finished automatically after searching all frequencies.
 - With this function, only FM stations with sufficient signal strength are stored automatically. If the station you want to program is weak in signal strength, tune to it in monaural manually and program it by following the procedure of the section "To store stations" on page 28.

<Europe and U.K. models only>

- The automatic preset tuning search is performed through all RDS network frequencies until stations are stored up to E8. If the number of received stations is not enough to be stored up to E8, the search will be finished automatically after searching all frequencies.
 - With this function, only RDS stations with sufficient signal strength are stored automatically. If the station you want to program is weak in signal strength, tune to it in monaural manually and program it by following the procedure of the section "To store stations" on page 28.
- * There may be a case that this function cannot receive a station which could be received by the automatic tuning method. This is because this function receives a large volume of PI (Program Identification) data along with the station.

■ Exchanging preset stations

You can exchange the places of two preset stations with each other as shown below.
(Example)

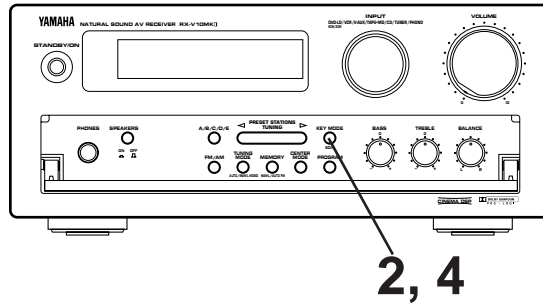

(Example)

If you want to exchange the preset stations on E1 and A5 with each other.

<p>1 Recall the preset station on E1 (by following the method of "To recall a preset station" on page 28).</p>	<p>4</p> <p>KEY MODE EDIT</p> <p>↓</p> <p>E 1 -- A 5</p> <p>Shows the exchange of stations is completed.</p>
<p>2</p> <p>KEY MODE EDIT</p> <p>→</p> <p>MEMO PRESET AUTO E 1</p> <p>Flashes.</p>	
<p>3 Recall the preset station on A5 by following the same method as in step 1.</p> <p>MEMO PRESET AUTO A 5</p> <p>Flashes.</p>	

In areas where RDS broadcasts cannot be received, the RDS broadcast functions do not operate. (Skip the procedures from pages 31 to 35.)

RECEIVING RDS STATIONS

Europe and U.K. models only

RDS (Radio Data System) is a data transmission system gradually being introduced by FM stations in many countries. Stations using this system transmit an inaudible stream of data in addition to the normal radio signal.

RDS data contains various information, such as PI (Program Identification), PS (Program Service name), PTY (Program Type), RT (Radio Text), EON (Enhanced Other Networks), etc.

RDS function is carried out among the network stations.

* This unit utilizes PS, PTY, RT and EON to receive RDS broadcast stations.

■ Displaying RDS data

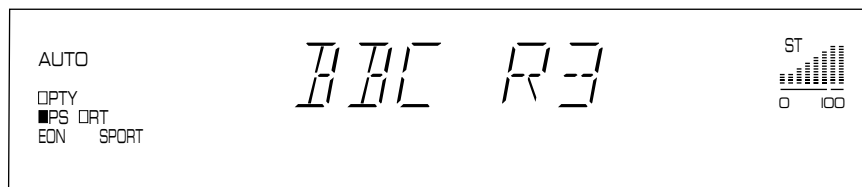

The following four modes are available in this unit for displaying RDS data.

PS (Program Service name) mode:

Displays the name of the RDS station now being received instead of the frequency.

PTY (Program Type) mode:

Displays the type of the program on the RDS station now being received. There are 15 program types for classifying RDS stations. Refer to the next page for details.

RT (Radio Text) mode:

Displays information about the program (such as the title of the song, name of the singer, etc.) on the RDS station now being received.

EON (Enhanced Other Networks) mode:

Select a program type with the EON button. The unit will automatically change to a station that starts to broadcast that type of program. When the program is finished, the unit will return to the original program.

Program types in the PTY mode

NEWS	News: Short accounts of facts, events and publicly expressed views, reportage and actuality.	VARIED	Varied: Used for mainly speech-based programs usually of light-entertainment nature, not covered by above categories. Examples are: quizzes, panel games, personality interviews, comedy and satire.
AFFAIRS	Current affairs: Topical program expanding or enlarging upon the news, generally in different presentation style or concept, including documentary debate, or analysis.	POP M	Pop: Commercial music, which would generally be considered to be of current popular appeal, often featuring in current or recent record sales charts.
INFO	Information: Program whose purpose is to impart advice in the widest sense, including meteorological reports and forecasts, consumer affairs, medical help, etc.	ROCK M	Rock: Contemporary modern music, usually written and performed by young musicians.
SPORT	Sport: Program concerned with any aspect of sport.	M.O.R. M	M.O.R.: (Middle of the Road Music). Common term to describe music considered to be “easy-listening”, as opposed to Pop, Rock or Classical. Music in this category is often but not always, vocal, and usually of short duration (< 5 min.)
EDUCATE	Education: Program intended primarily to educate, of which the formal element is fundamental.	LIGHT M	Light classics: Classical Musical for general, rather than specialist appreciation. Examples of music in this category are instrumental music, and vocal or choral works.
DRAMA	Drama: All radio plays and serials.	CLASSICS	Serious classics: Performances of major orchestral works, symphonies, chamber music etc., and including Grand Opera.
CULTURE	Culture: Programs concerned with any aspect of national or regional culture, including religious affairs, philosophy, social science, language, theatre, etc.	OTHER M	Other music: Musical styles not fitting into any of the above categories. Particularly used for specialist music, of which Jazz, Rhythm & Blues, Folk, Country, and Reggae are examples.
SCIENCE	Science: Programs about the natural sciences and technology.		

Changing the RDS modes

When an RDS station is received, "PS", "PTY" and/or "RT" that correspond to the RDS data services employed by the station light up on the display. By pressing the **RDS MODE/FREQ** button once or more, you can change the display mode among the RDS modes employed by the received station in the order shown below. (The RDS mode not employed by the station cannot be selected.) Illumination of the indicator on the head of a name of RDS mode shows that the corresponding RDS mode is now selected.

* When an RDS station is received, do not press the **RDS MODE/FREQ** button until one or some names of RDS modes light up on the display. If the button is pressed before one or some names light up on the display, the mode cannot be changed. This is because the unit has not received all of the RDS data on the station yet.

* If no name of RDS mode lights up on the display, the mode cannot be changed.

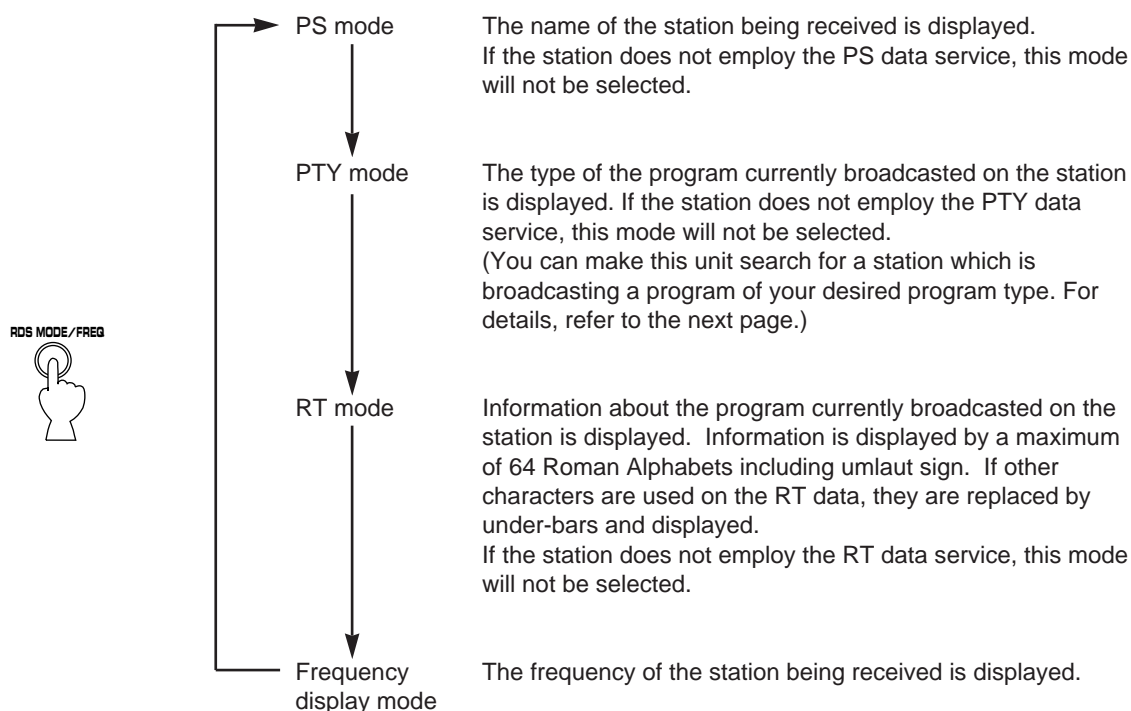

Notes

- RDS data service cannot be utilized by this unit if the received signal is not strong enough. Especially, the RT (Radio Text mode) needs sufficient data to be received, so the RT mode may not display even if other RDS modes (PS, PTY, etc.) are displayed.
- RDS data reception may not be possible due to poor reception conditions. If so, press the **TUNING MODE** button so that the "AUTO" indicator goes off from the display. Though the reception mode is changed to monaural by this operation, when you change the display to an RDS mode, RDS data may be displayed.
- If the signal strength gets weakened by external interference when receiving an RDS station, the RDS data service may be cut off suddenly and "...WAIT" will light up on the display.

■ Selecting your desired program type from among preset RDS stations (PTY SEEK)

By designating a program type, the unit automatically searches all preset stations for an RDS station which broadcasts a program of the program type.

* There are 15 program types for classifying RDS stations. For details, refer to page 32.

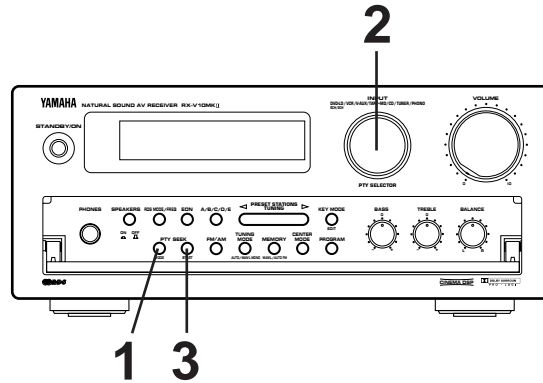

1 Set the unit in the PTY SEEK mode.

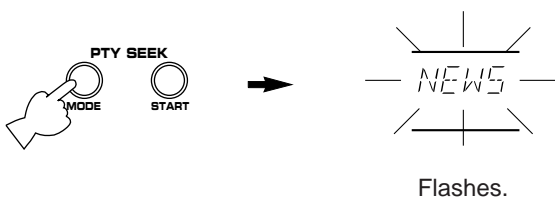

* The program type of the station now being received or "NEWS" flashes on the display.

2 Select the desired program type.

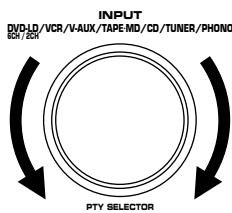

3 Begin searching all preset RDS stations.

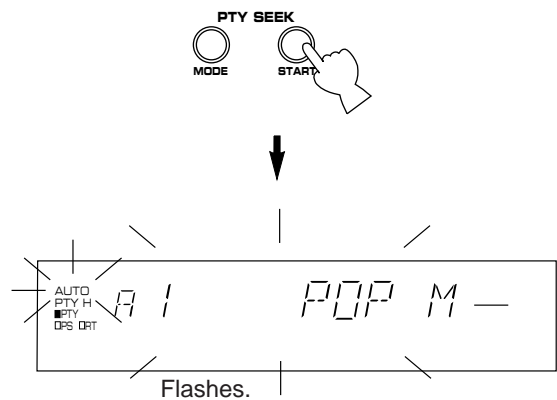

* The "PTY H" indicator will be illuminated on the display.

- If a station which broadcasts the selected program type is found, the unit stops at the station and the program type will be illuminated.
- If the selected station is not the desired one, press the **PTY SEEK START** button once more. The unit begins searching for another station which broadcasts the same program type.
- To stop the search, press the **PTY SEEK START** button once more.

To cancel this function

If the **PTY SEEK MODE** button is pressed once more, the PTY SEEK mode is canceled.

■ Automatic selection of desired program when broadcasting starts

This function uses the EON (Enhanced Other Networks) data service on the RDS station network.

By only selecting a desired program type (NEWS, INFO, AFFAIRS or SPORT), this unit automatically searches all preset RDS stations for a station that broadcasts that program type (though you cannot check the searching process), and, if found, receives a program when its broadcast starts in place of the program now being received.

* This function can be used only when an RDS station that employs the EON data service is received. (When such a station is received, the "EON" indicator will be illuminated on the display.)

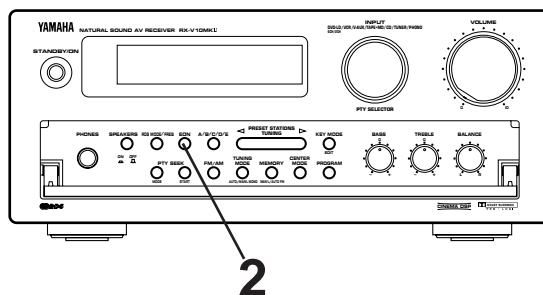

- 1** Make sure that the "EON" indicator is illuminated on the display.

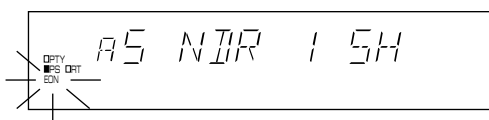

* If the "EON" indicator is not illuminated on the display, receive an (or another) RDS station so that the "EON" indicator will be illuminated on the display.

- 2** Select the desired program type, NEWS, INFO, AFFAIRS or SPORT.



Press once or more.

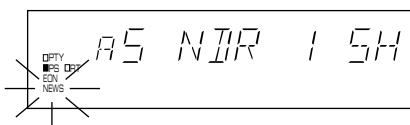

Becomes illuminated.

The search is performed among all preset RDS stations internally. If a program is found, the program is automatically received when its broadcast starts.

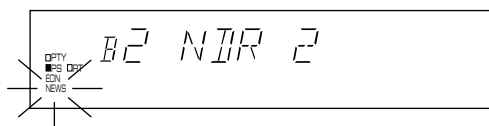

Flashes.

- 3** When the broadcast of the selected program ends, the previously received program (or another program on the same station) is recalled.

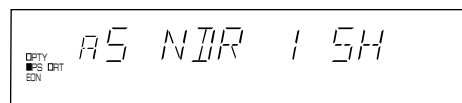

To cancel this function

Press the **EON** button once or more until no program type name is illuminated on the display.

USING DIGITAL SOUND FIELD PROCESSOR (DSP)

This unit incorporates a sophisticated, multi-program digital sound field processor. The processor allows you to electronically expand and change the shape of the audio sound field from both audio and video sources, creating a theater-like experience in your listening room. You can create an excellent audio sound field by selecting a suitable sound field program (this will, of course, depend on what you will be listening to), and adding desired adjustments.

In addition, this unit incorporates a Dolby Pro Logic Surround decoder for multi-channel sound reproduction of sources encoded with Dolby Surround. The operation of the Dolby Pro Logic Surround decoder can be controlled by selecting a corresponding DSP program including a combined operation of Yamaha DSP and Dolby Pro Logic Surround.

■ Brief Overview of Digital Sound Field Programs

The following list gives you a brief description of the sound fields produced by each of the DSP programs. Keep in mind that most of these are precise digital recreations of actual acoustic environments. The data for these sound fields was recorded at actual locations using sophisticated sound field measurement equipment.

Note
The channel level balance between the left and right rear effect speakers may vary depending on the sound field you are listening in. This is due to the fact that most of these sound field recreations are actual acoustic environments.

PROGRAM	FEATURE
<input checked="" type="checkbox"/> PRO LOGIC	This program is used for playback of sources encoded with Dolby Surround. Dialog is oriented on the screen and effect sounds are effectively located on the left front, right front and rear surround sides respectively as the movie sound creator designed.
<input checked="" type="checkbox"/> PRO LOGIC ENHANCED	This program is used for playback of sources encoded with Dolby Surround. Enhancing the "Normal" Dolby Pro Logic, the DSP technology simulates the multi-surround speaker systems of a 35 mm movie theater. This effect creates a wide surround sound field, and expands the sound stage with an improved presence image. This program is suitable for musical based movies, as well as drama and action based movies.
CONCERT VIDEO	This program is effective for music videos and gives excellent depth and clarity for vocals. For opera, the orchestra and stage are ideally recreated, letting you feel as if you were in an actual concert hall.
MONO MOVIE	This program is designed specifically to enhance mono source programs. Compared to a strictly mono setting, the sound image created in this mode is wider and slightly forward of the speaker pair, lending an immediacy to the overall sound. It is particularly effective when used with old mono movies, news broadcasts and dialog.
ROCK CONCERT	This program is ideally suited for rock music. You will experience a very dynamic or lively sound field.
CONCERT HALL	In this program, the center will appear to be deep behind the main speakers, creating an expansive large hall ambience. Orchestra and opera music are suited for this sound field.

■ Playing a source with an effect of the digital sound field processor (DSP)

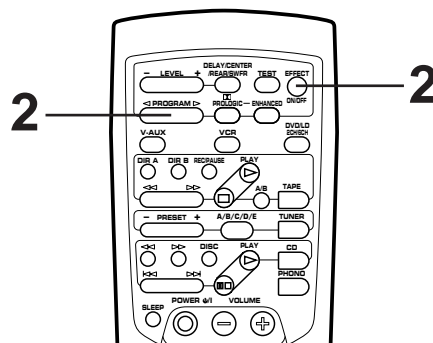
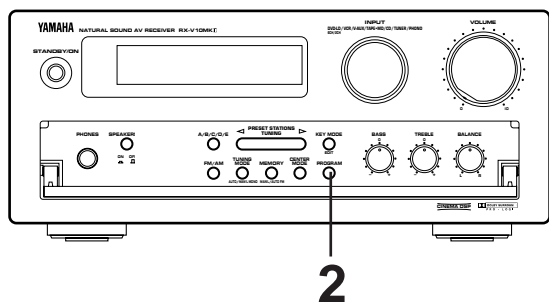

1 Follow steps 1 – 6 shown in “Playing a source” on page 24.

2 Select a program that is suitable for the source.

On the front panel:



Press the button repeatedly until the name of desired program lights up on the display.

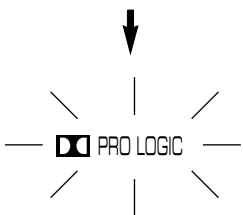

On the remote controller:

a)

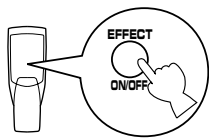

Turn on the DSP so that a program name lights up on the display.

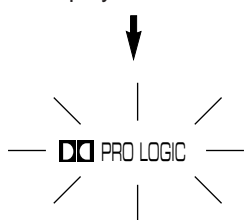

b)

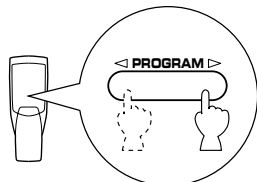

Select a desired program confirming it on the display.

The selected program name is shown on the display.

3 Adjust the delay time and the output level of each speaker. (For details, refer to the corresponding descriptions on pages 38 and 39.)

On the remote controller:

Pressing the **PROLOGIC** or **ENHANCED** key turns on the DSP and selects the corresponding program directly.

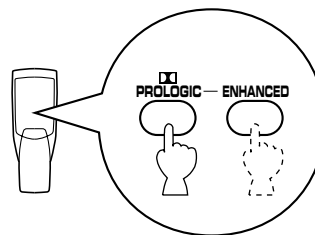

Notes

- Program selection can be made to individual input sources. Once you select a program, it is linked with the input source selected at this time. So, when you select the input source the next time, the same program will be automatically recalled.
- If you prefer to cancel the DSP, press the **EFFECT** button. The sound will be the normal 2-channel stereo without surround sound effect.
- When **CONCERT VIDEO**, **MONO MOVIE**, **ROCK CONCERT** or **CONCERT HALL** is selected, no sound is heard from the center speaker.
- When a monaural sound source is played with **PRO LOGIC** or **PRO LOGIC ENHANCED**, no sound is heard from the rear speakers.
- When this unit's Dolby Pro Logic Surround decoder is used, if the main-source sound is considerably altered by overadjustment of the **BASS** or **TREBLE** control, the sound effect between the center and rear channels may be unnatural.

Adjustment of the CENTER LEVEL

You can adjust the sound output level of the center speaker even if the output level is already set in “**SPEAKER BALANCE ADJUSTMENT**” on page 21.

- 1 Press the **DELAY/CENTER/REAR/SWFR** key repeatedly until “CNTR” appears in the display.

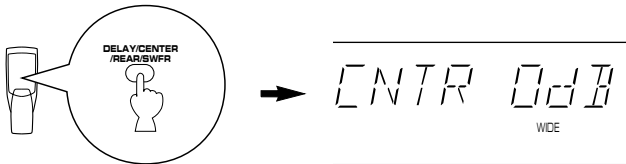

- 2 By continuously pressing the “+” or “-” side of the **LEVEL** button, the level value changes continuously.

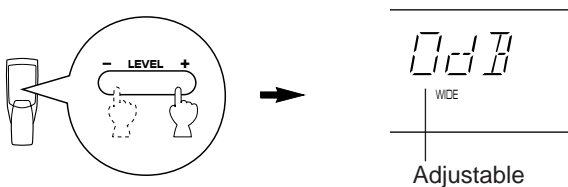

Control range: MIN, -20 to +10 dB

Notes

- This adjustment can be made only when the digital sound field program **PRO LOGIC** or **PRO LOGIC ENHANCED** is selected, or the “DVD/LD 6CH” input source mode is selected.
- Once the output level is adjusted, the level value will be the same in the **PRO LOGIC** and **PRO LOGIC ENHANCED** programs and the “DVD/LD 6CH” input source mode.

Adjustment of the REAR LEVEL

You can adjust the sound output level of the rear speakers even if the output level is already set in “**SPEAKER BALANCE ADJUSTMENT**” on page 21.

- 1 Press the **DELAY/CENTER/REAR/SWFR** key repeatedly until “REAR” appears in the display.

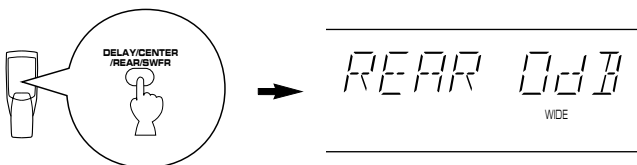

- 2 By continuously pressing the “+” or “-” side of the **LEVEL** button, the level value changes continuously.

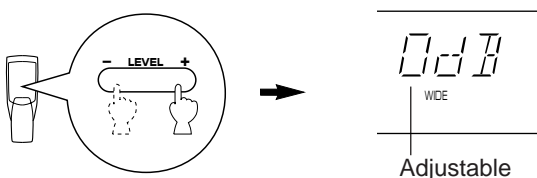

Control range: MIN, -20 to +10 dB

Notes

- This adjustment can be made only when the built-in digital sound field processor is on, or the “DVD/LD 6CH” input source mode is selected.
- Once the output level is adjusted, the level value will be the same in all the digital sound field programs and the “DVD/LD 6CH” input source mode.

Adjustment of DELAY TIME

You can adjust the time difference between the beginning of the sound from the main speakers and the beginning of the effect sound from the rear speakers.

The larger the value, the later the effect sound is generated.

This adjustment can be made to all programs individually.

PRO LOGIC	: from 15 to 30 milliseconds (Preset value: 20 milliseconds)
PRO LOGIC ENHANCED	: from 15 to 30 milliseconds (Preset value: 20 milliseconds)
CONCERT VIDEO	: from 1 to 100 milliseconds (Preset value: 28 milliseconds)
MONO MOVIE	: from 1 to 100 milliseconds (Preset value: 20 milliseconds)
ROCK CONCERT	: from 1 to 100 milliseconds (Preset value: 17 milliseconds)
CONCERT HALL	: from 1 to 100 milliseconds (Preset value: 30 milliseconds)

- 1 Press the **DELAY/CENTER/REAR/SWFR** key repeatedly until "DELAY" appears in the display.

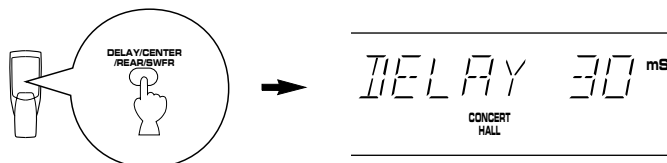

- 2 By continuously pressing the "+" or "-" side of the **LEVEL** button, the value changes continuously. The value stops changing momentarily at the preset point.

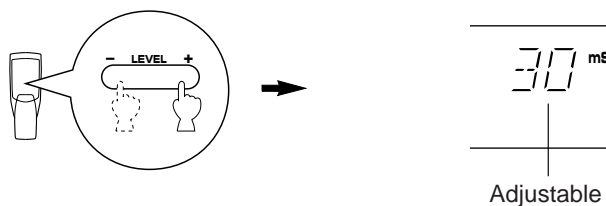

Notes

- When the **LEVEL** button is pressed, sound is momentarily interrupted.
- Adding too much delay will cause an unnatural effect with some sources.

Note

The values of the delay time, center level, rear level and subwoofer output level you set the last time will remain memorized even when this unit is in the standby mode. However, if the power cord is disconnected for more than one week, these values will be automatically changed to the factory default settings.

TROUBLESHOOTING

Refer to the chart below when this unit does not function properly. If the problem you are experiencing is not listed below or if the instruction below does not help, disconnect the power cord and contact your authorized YAMAHA dealer or service center.

	Problem	Cause	What to Do
Amplifier	The unit fails to turn on when the STANDBY/ON switch is pressed, or turns into the standby mode suddenly soon after the power is turned on.	Power cord is not plugged in or is not completely inserted.	Firmly plug in the power cord.
	This unit does not work normally.	There is an influence of strong external noise (lightning, excessive static electricity, etc.) or a misoperation on this unit while using this unit.	Turn this unit into the standby mode and disconnect the AC power cord from the AC outlet. After about 30 seconds pass, connect the power and operate this unit again.
	No sound or no picture.	Incorrect output cord connections.	Connect the cords properly. If the problem persists, the cords may be defective.
		Appropriate input source is not selected.	Select an appropriate input source with the INPUT selector.
		Speaker connections are not secure.	Secure the connections.
		The SPEAKERS switch is set to the OFF position.	Set the SPEAKERS switch to the ON position.
	The sound suddenly goes off.	The protection circuit has been activated because of short circuit etc.	Turn this unit into the standby mode, and then turn on to reset the protection circuit.
		The SLEEP timer came on.	Cancel the SLEEP timer function.
	Only one side speaker outputs the sound.	Incorrect setting of the BALANCE control.	Adjust it to the appropriate position.
		Incorrect cord connections.	Connect the cords properly. If the problem persists, the cords may be defective.
	Sound "hums".	Incorrect cord connections.	Firmly connect the audio plugs. If the problem persists, the cords may be defective.
		No connection from the turntable to the GND terminal.	Make the GND connection between the turntable and this unit.
	The volume level is low while playing a record.	The record is being played on a turntable with an MC cartridge.	The player should be connected to the unit through the MC head amplifier.
	The volume level cannot be increased, or sound is distorted.	The component connected to the TAPE/MD OUT terminals of this unit is turned off.	Turn the power to the component on.
	No sound from the rear speakers.	The sound output level to the rear speakers is set to minimum.	Raise the sound output level to the rear speakers.
The monaural sound source is played when <input checked="" type="checkbox"/> PRO LOGIC or <input checked="" type="checkbox"/> PRO LOGIC ENHANCED is selected.		Select another program suitable for the monaural sound source.	
No sound from the center speaker.	The sound output level to the center speaker is set to minimum.	Raise the sound output level to the center speaker.	
	The center channel mode is in PHANTOM mode.	Select NORMAL or WIDE.	
	Incorrect sound field program selection.	Select the appropriate program.	
FM	FM stereo reception is noisy.	Because of the characteristics of FM stereo broadcasts, this is limited to cases where the transmitter is too far away or the antenna input is poor.	Check the antenna connections. Try using a high quality directional FM antenna. Set the TUNING MODE button to the manual tuning mode.
	There is distortion and clear reception cannot be obtained even with a good FM antenna.	There is multipath interference.	Adjust antenna placement to eliminate multipath interference.
	A desired station cannot be tuned in with the automatic tuning method.	The station is too weak.	Use the manual tuning method. Use a high quality directional FM antenna.
	Previously preset stations can no longer be tuned in.	This unit has been unplugged for a long period.	Repeat the presetting procedure.
AM	A desired station cannot be tuned in with the automatic tuning method.	Weak signal or loose antenna connections.	Tighten the AM loop antenna connections and rotate it for best reception. Use the manual tuning method.
	There are continuous crackling and hissing noises.	Noises result from lightning, fluorescent lamps, motors, thermostats and other electrical equipment.	Use an outdoor antenna and a ground wire. This will help somewhat but it is difficult to eliminate all the noises.
	There are buzzing and whining noises (especially in the evening).	A television set is being used nearby.	Relocate this unit away from the TV.
REMOTE CONTROLLER	The remote controller does not work.	Direct sunlight or lighting (of an inverter type of fluorescent lamp etc.) is striking the remote control sensor of the main unit.	Change the position of the main unit.
		The batteries of this remote controller are too weak.	Replace the batteries with new ones.
Others	The sound is degraded when listening with the headphones connected to the compact disc player or cassette deck that is connected with this unit.	This unit is in the standby mode.	Turn the power to this unit on.

SPECIFICATIONS

AUDIO SECTION

Minimum RMS Output Power per Channel	
MAIN L, R	8 ohms, 20 Hz to 20 kHz, 0.04% THD45W+45W
CENTER	8 ohms, 1 kHz, 0.04% THD45W
REAR L,R	8 ohms, 1 kHz, 0.3% THD15W+15W
Dynamic Power per Channel (by IHF Dynamic Headroom measuring method)	8 ohms65W+65W 6 ohms75W+75W 4 ohms95W+95W 2 ohms105W+105W
DIN Standard Output Power per Channel	4 ohms, 1 kHz, 0.7% THD [Europe model only]60W+60W
IEC Power per Channel	8 ohms, 1 kHz, 0.1% THD [Europe model only]50W+50W
Power Band Width	8 ohms, 22.5W, 0.1% THD10 Hz to 50 kHz
Maximum Power per Channel [General model only]	MAIN L, R (1 kHz, 10% THD, 8 ohms)65W+65W
Input Sensitivity/Impedance	PHONO MM2.5 mV/47 k-ohms CD/TAPE-MD/DVD-LD/VCR/V-AUX150 mV/47 k-ohms
6CH DISCRT INPUT	MAIN L, R150 mV/70 k-ohms CENTER150 mV/40 k-ohms SURROUND L, R90 mV/40 k-ohms SUBWOOFER150 mV/40 k-ohms
Maximum Input Signal (1 kHz, 0.5% THD)	PHONO MM100 mV CD/TAPE-MD/DVD-LD/VCR/V-AUX (EFFECT ON)2.5V
Output Level/Impedance	REC OUT150 mV/0.9 k-ohms SUBWOOFER3.5V/1.6 k-ohms
Headphone Jack Rated Output/Impedance	Output Level (8 ohms, 1 kHz, 150 mV Input)0.45V Impedance330 ohms
Frequency Response (20 Hz to 20 kHz)	CD/TAPE-MD/DVD-LD/VCR/V-AUX0±0.5 dB
RIAA Equalization Deviation	PHONO MM0±0.5 dB
Total Harmonic Distortion	PHONO MM to REC OUT 20 Hz to 20 kHz, 1V0.02% CD/TAPE-MD/DVD-LD/VCR/V-AUX to SP OUT 20 Hz to 20 kHz, 22.5W/8 ohms0.02%

Signal-to-Noise Ratio (IHF-A Network)	
PHONO MM to REC OUT (5 mV Input Shorted)82 dB	
CD/TAPE-MD/DVD-LD/VCR/V-AUX to SP OUT (Shorted)95 dB	
Residual Noise (IHF-A Network)	MAIN L/R140 µV
Channel Separation (Vol. MAX, EFFECT OFF)	PHONO MM (Input Shorted, 1 kHz)60 dB CD/TAPE-MD/DVD-LD/VCR/V-AUX (Input 5.1 k-ohms Terminated, 1 kHz)60 dB
Tone Control Characteristics	BASS: Boost/cut±10 dB (50 Hz) Turnover Frequency(350 Hz) TREBLE: Boost/cut±10 dB (20 kHz) Turnover Frequency(3.5 kHz)
Gain Tracking Error (0 to -60 dB)3 dB	

VIDEO SECTION

Video Signal Level1 Vp-p/75 ohms	
Maximum Input Level1.5 Vp-p	
Signal-to-Noise Ratio50 dB	
Monitor Out Frequency Response5 Hz to 10 MHz, -3 dB	

FM SECTION

Tuning Range87.5 to 108.0 MHz	
50 dB Quieting Sensitivity (IHF, 1 kHz, 100% mod., 75 ohms) [General model only]	Mono1.6 µV (15.3 dBf) Stereo23 µV (38.5 dBf)
Usable Sensitivity (75 ohms)	DIN, Mono (S/N 26 dB) [Europe and U.K. models]0.9 µV DIN, Stereo (S/N 46 dB) [Europe and U.K. models]28 µV
Alternate Channel Selectivity [General model]75 dB	
Selectivity (two signals, 40 kHz Dev., ±300 kHz) [Europe and U.K. models]55 dB	
Signal-to-Noise Ratio (IHF) Mono/Stereo	[General model]80 dB/75 dB (DIN-Weighted, 40 kHz Dev.) Mono/Stereo [Europe and U.K. models]74 dB/69 dB
Harmonic Distortion	Mono/Stereo (1 kHz) [General model]0.1/0.2% Mono/Stereo (40 kHz Dev.) [Europe and U.K. models]0.1/0.2%

Stereo Separation (1 kHz)	
[General model]48 dB	
[Europe and U.K. models (40 kHz Dev.)]48 dB	
Frequency Response	30 Hz to 15 kHz0 ±1 dB

AM SECTION

Tuning Range	[General model]530 to 1,710 kHz [Europe and U.K. models]531 to 1,611 kHz
Usable Sensitivity300 µV/m	
Signal-to-Noise Ratio50 dB	
AUDIO SECTION	
Output Level	FM (100% mod., 1 kHz) [General model]500 mV [Europe and U.K. models (40 kHz Dev.)]400 mV AM (30% mod., 1 kHz)150 mV

GENERAL

Power Supply	[U.K. model]AC 230V, 50 Hz [Europe model]AC 230V, 50 Hz [General model]AC 110/120/220/240V, 50/60 Hz
Power Consumption160W	
Maximum Power Consumption [General model only]360W	
AC Outlets	2 SWITCHED OUTLETS [Europe and General models]100W max. total 1 SWITCHED OUTLET [U.K. model]100W max. total
Dimensions (W x H x D)280 x 119 x 389 mm (11" x 4-11/16" x 15-5/16")
Weight7.3 kg (16 lbs. 1 oz.)	
AccessoriesAM loop antenna Indoor FM antenna Remote controller Batteries	75-ohm/300-ohm antenna adapter (U.K. model only)

Specifications are subject to change without notice.



YAMAHA ELECTRONICS CORPORATION, USA 6660 ORANGETHORPE AVE., BUENA PARK, CALIF. 90620, U.S.A.
YAMAHA CANADA MUSIC LTD. 135 MILNER AVE., SCARBOROUGH, ONTARIO M1S 3R1, CANADA
YAMAHA ELECTRONIK EUROPA G.m.b.H. SIEMENSSTR. 22-34, 25462 RELLINGEN BEI HAMBURG, F.R. OF GERMANY
YAMAHA ELECTRONIQUE FRANCE S.A. RUE AMBROISE CROIZAT BP70 CROISSY-BEAUBOURG 77312 MARNE-LA-VALLEE CEDEX02, FRANCE
YAMAHA ELECTRONICS (UK) LTD. YAMAHA HOUSE, 200 RICKMANSWORTH ROAD WATFORD, HERTS WD1 7JS, ENGLAND
YAMAHA SCANDINAVIA A.B. J A WETTERGRENS GATA 1, BOX 30053, 400 43 VÄSTRA FRÖLUNDA, SWEDEN
YAMAHA MUSIC AUSTRALIA PTY, LTD. 17-33 MARKET ST., SOUTH MELBOURNE, 3205 VIC., AUSTRALIA

YAMAHA CORPORATION
Printed in Malaysia  V289750